

FIAT ALFA ROMEO BMW  
MINI PSA FORD JAGUAR  
LAND ROVER JEEP  
CHRYSLER MERCEDES  
BENTLEY  
NISSA  
VAG



# KIT DI MESSA IN FASE

[www.jbmcamp.com](http://www.jbmcamp.com)

2025

# SOMMARIO

FIAT/ALFA ROMEO	4
BMW/MINI	8
PSA	17
FORD	20
JAGUAR/LAND ROVER	27
JEEP/CHRYSLER	30
MERCEDES-BENZ	31
RENAULT/DACIA/NISSAN	34
OPEL/VAUXHALL	38
VAG	44
ALTRI	54
STRUMENTI AUSILIARI	56





Trova il kit di cui hai bisogno in pochi secondi. Veloce ed efficiente!



### RICERCA RAPIDA

Trova il kit compatibile con qualsiasi veicolo



### FILTRI AVANZATI

Affina la ricerca per marca, motore, OEM o riferimento JBM



### RISULTATI PRECISI

Accedi a tutte le informazioni di cui hai bisogno con un solo clic

## 1 INSERISCI LE INFORMAZIONI DEL VEICOLO

Vai sul nostro sito web e trova la sezione Timing Tool Finder

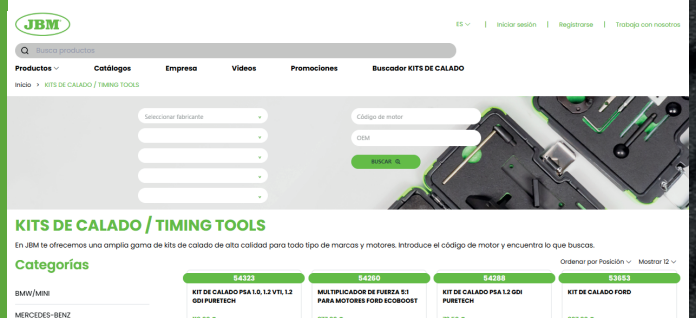

Seleccionar fabricante

Four vertical dropdown menus for selecting manufacturer, model, cylinder, and year.

## 2 SELEZIONA I CAMPI DI RICERCA

Produttore, modello, cilindrata, codice motore e anno

OPPURE INSERISCI IL CODICE MOTORE O IL CODICE OEM DI RICERCA

Search input fields for 'Código de motor', 'OEM', and a 'BUSCAR' button with a magnifying glass icon.

CONFRONTA I RISULTATI E TROVA IL TUO KIT DI MESSA IN FASE



## 54471

2.80 - 5 112

FIAT/LANCIA-1,6 FRETWORK KIT



### MODELLO

FIAT BRAVA (1995-2002)  
FIAT BRAVO (1995 - 2002)  
FIAT DOBLO CARGO (2002-2010)  
FIAT DOBLO (2002 - 2010)  
FIAT MAREA WEEKEND (1996-2003)  
FIAT MAREA (1996-2003)  
FIAT MULTIPLA (1999-2011)  
FIAT PALIO WEEKEND (1997-2006)  
FIAT SIENA (1997-2003)  
FIAT STILO (2001-2008)  
LANCIA DEDRA (1997-1999)  
LANCIA DELTA (1996-1999)  
LANCIA LYBRA (1999-2006)

### UTENSILI OEM

1.860.771.000  
1.860.874.000  
1.860.876.000

### CODICE MOTORE

1.6 16v - 178.B3.000  
178B3.000  
182A4.000  
182A6.000  
182B6.000

## 53303

1.96 - 5 120

KIT DI ATTREZZI DI REGOLAZIONE  
CINGHIA DENTATA PER FIAT / OPEL



### MODELLO

ALFA ROMEO 145, 146, 146 JTD  
FIAT 1.9D, 2.4D  
GM 1.3, 1.6, 1.9, 2.0, 2.4 CDTI (2004 - )

### UTENSILI OEM

EN-46781  
EN-46785  
EN-46788  
EN-46789  
EN-46789-100

### CODICE MOTORE

A20DT	188A2.000	223A7.000
A20DTLBS	188A7.000	323.02
A20DTLBX	188B2.000	350A2.000
A20DTLBY	192A1.000	371.01
A20DTLCD	192A3.000	937A2.000
Z19DT	192A5.000	937A3.000
Z19DTH	192A8.000	939A1.000
Z19DTJ	192A9.000	939A5.000
Z19DTL	192B4.000	939A7.000
182B4.000	192B5.000	
182B9.000	198A2.000	
186A6.000	198A3.000	
186A8.000	198A6.000	
186A9.000	199A5.000	

## 53304

6.00 - 2 42

KIT DI ATTREZZI DI REGOLAZIONE  
CINGHIA DENTATA PER FIAT

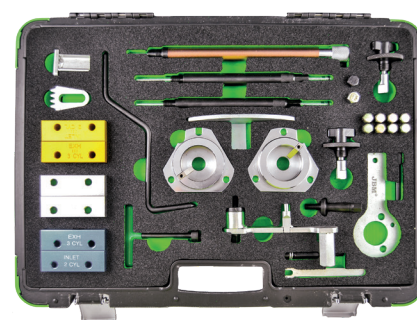

### MODELLO

FIAT 1.2, 1.4, 1.6, 1.8 16V  
FIAT 1.9D/TD, 1.9JTD, 2.4TD/JTD

### UTENSILI OEM

0153A	1860876000	6079
1822149000	1860892000	976554
1822154000	1860895000	D86
1825041000	1860898000	FACOMD86
1825042000	1860901000	KM571A
1860161000	1860905000	MOT.582-01
1860443000	1860905010	T10170A
1860703000	1860932000	T10170A/1
1860766000	1860933000	VAS6079
1860771000	1867030000	
1860846000	1895879000	
1860847000	3313	
1860874000	6012T	
1860875000	607589014000	

### CODICE MOTORE

DHX	176B9.000	182B2.000
DJY	178B3.000	182B6.000
D8B	182A4.000	185A2.000
D9B	182A6.000	188A3.000
P8C	182A7.000	188A5.000
160A7.000	182A8.000	223A6.000

## 53306

1.70 - 5 135

KIT DI ATTREZZI DI REGOLAZIONE CINGHIA DENTATA PER FIAT 1.2 16V



### MODELLO

FIAT 1.2 16V

### UTENSILI OEM

EN 46781  
0104 A  
0991768610  
104 A  
1860985000  
1871000900  
2000004500  
2000015800  
2190754500  
303 1472

### CODICE MOTORE

169A3.000	312B6.000
176B9.000	843A1.000
182B2.000	940A6.000
188A5.000	940B1.000
192B2.000	940B7.000
198A1.000	940B8.000
198A4.000	955A1.000
199A6.000	
199A8.000	
312A1.000	
312A3.000	
312A9.000	
312B3.000	
312B4.000	

### 53308

1.09 5 10 120

KIT DI ATTREZZI DI REGOLAZIONE CINGHIA DENTATA PER ALFA ROMEO



#### MODELLO

SPIDER/GTV (96-05)  
PÙRPURA / PURPLE: 1.4, 1.6 / AZUL / BLUE: 1.8, 2.0  
145/146 (96-01), 147 (01-10), 155/156 (95-02), 166 (98-07),  
145/146, (96-01), 155/156 (96-06), SPIDER/GTV (98-05),  
2.0 16V;  
145, 146, 147, 155, 156, 1.4 1.6 1.8 2.0 TS, 1.4/1.6 16V;  
145/146/147/155/156 (96-10), 1.8 16V;

#### UTENSILI OEM

1822149000  
1822154000  
1825041000  
1825042000

#### CODICE MOTORE

162.01  
322.01  
323.01  
323.10  
335.03  
671.06  
672.04  
676.01

### 53309

5.60 2 40

KIT DI ATTREZZI DI REGOLAZIONE CINGHIA DENTATA PER ALFA/FIAT/LANCIA 1.4, 1.6, 1.8, 2.0 16V, 2.0 20V

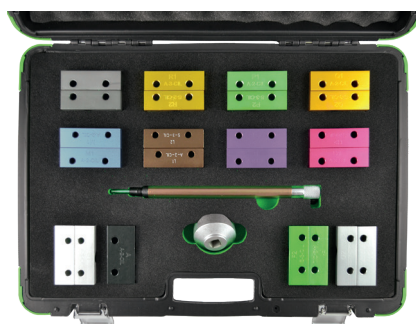

#### MODELLO

1.4 16V, 1.6 16V, 1.8 16V, 2.0 16V, 2.0 20V

#### UTENSILI OEM

175A3.000	1.860.875.000
182A1.000	1.860.895.000
182A2.000	1.860.899.000
182B7.000	1.860.961.000
1.822.110.000	1.870.697.000
1.825.013.000	1.870.734.000
1.825.041.000	1.870.797.000
1.825.042.000	1.870.859.000
183A1.000	188A6.000
183A6.000	1.895.879.000
185A8.000	192A4.000
1.850.892.000	
1.852.161.000	
1.860.847.000	

#### CODICE MOTORE

162.01	335.03
322.01	671.06
323.01	672.04
323.10	676.01

### 53312

2.60 5 160

KIT DI ATTREZZI DI REGOLAZIONE CINGHIA DENTATA PER FIAT/ALFA/FORD



#### MODELLO

ALFA ROMEO: MITO (10-15)  
CHRYSLER: YPSILON  
FIAT: NEW 500 (07-09), IDEA (04-09), LINEA (07-09),  
GRANDE PUNTO (07-09), DOBLO 1 CARGO (05-09),  
PANDA EVO2 (05)  
FORD: KA 1.2 DURATEC (09)  
LANCIA: YPSILON, MUSA

#### UTENSILI OEM

EN50780	2190754400
EN50782	2190754500
1860987000	3031477
1870823000	3031478
2000004000	3031479
2000004200	3031480
2000004300	3031560
2000004400	
2000004500	
2190754200	

#### CODICE MOTORE

169A.4000  
188A.4000  
199A.4000  
199A.7000  
350A1000

### 53319

0.60 10 40 1200

ATTREZZO DI REGOLAZIONE CINGHIA DENTATA PER FIAT IVECO 2.3, 3.0 JTD



#### MODELLO

FIAT 2.3, 3.0 JTD  
IVECO DAILY

#### UTENSILI OEM

0132AB	303-732
0178D	4527TS2
0194A	49JE02018
077440010400	5711TD
07LAG-PT20100	99360608
1.860.617000	99360614
119790	99360615
18G1671	9997169
2000018200	KM-6349
21-260	

#### CODICE MOTORE

FIAE0481A	FIAE0481R	FIAFL411C	FICE0481FB	FICE34818
FIAE0481B	FIAE0481RA	FIAGL411A	FICE0481H	FICFA401A
FIAE0481C	FIAE0481UA	FIAGL411B	FICE0481HA	FICFL411E
FIAE0481D	FIAE0481UB	FIAGL411C	FICE0481HB	FICFL411F
FIAE0481F	FIAE0481VA	FIAGL411D	FICE3481C	FICFL411G
FIAE0481FA	FIAE0481VB	FIAGL411M	FICE3481CC	FICFL411H
FIAE0481FB	FIAE3481A	FICE0114A	FICE3481D	FICFL411J
FIAE0481G	FIAE3481B	FICE0441A	FICE3481DM	FICFL411V
FIAE0481GA	FIAE3481C	FICE0441F	FICE3481E	FICFL411W
FIAE0481GB	FIAE3481D	FICE0481A	FICE3481J	FICGL411A
FIAE0481H	FIAE3481E	FICE0481B	FICE3481K	FICGL411B
FIAE0481HA	FIAE3481G	FICE0481D	FICE3481LC	FICGL411C
FIAE0481HB	FIAFL411A	FICE0481F	FICE3481M	F30DTE
FIAE0481N	FIAFL411B	FICE0481FA	FICE3481N	

## 54202

1.95 - 5 240

KIT DI ATTREZZI DI CRONOMETRAGGIO DEL MOTORE PER FIAT/ALFA ROMEO/LANCIA



### MODELLO

1.2 16V, 1.4 16V, T-JET

### UTENSILI OEM

1.860.985.000  
1.860.987.000  
1.860.992.000  
2.000.004.500  
2.000.015.800

### CODICE MOTORE

169A3.000  
176B9.000  
182B2.000  
188A5.000  
192B2.000  
198A1.000  
198A4.000  
198A8.000  
199A6.000  
312A1.000  
312A3.000  
843A1.000  
955A1.000

## 54203

2.70 - 5 135

KIT DI ATTREZZI DI CRONOMETRAGGIO DEL MOTORE PER ALFA ROMEO/LANCIA 1.8 TBI



### MODELLO

ALFA ROMEO 1,75 TBI  
LANCIA 1,75 DI TURBO JET

### UTENSILI OEM

1 860 898 000  
2 000 003 000  
2 000 033 500

### CODICE MOTORE

40A1.000  
939B1.000  
940B2.000  
960A1.000

## 54211

1.95 - 5 135

KIT DI ATTREZZI DI CRONOMETRAGGIO DEL MOTORE PER FIAT/FORD/OPEL/SUZUKI 1.3L

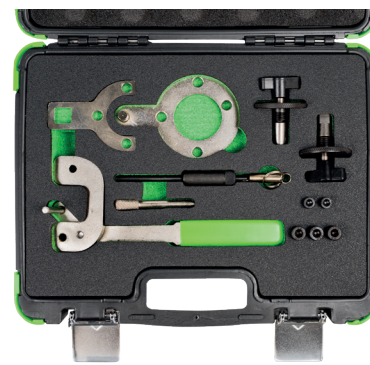

### MODELLO

FIAT 1.3 JTD  
FORD 1.3 TDCI  
OPEL 1.3 CDTI  
SUZUKI 1.3 CDTI

### UTENSILI OEM

EN 46781	1870900400
EN 46785	1871000200
KM 955	1871000900
KM-662-C	303-1468
09912-38300	303-1469
09917-68610	303-1472
1860985000	
1870900300	

### CODICE MOTORE

Z13DT  
Z13DTH  
Z13DTJ  
169A.000  
188A8.000  
188A9.000  
199A3.000

## 53310

10.70 - 2 44

KIT DI ATTREZZI DI REGOLAZIONE CINGHIA DENTATA PER FIAT/ALFA/LANCIA



### MODELLO

1.2, 1.4 16V, 1.6 16V, 1.6 16V ECO, 1.8, 2.0, 2.0 16V, 2.4 20V, 3.0 20V, V6

### UTENSILI OEM

0153A	1860847000	1860933000	T10170A
1822149000	1860874000	1867030000	T10170A/1
1822154000	1860875000	1895879000	VAS6079
1825041000	1860876000	3313	
1825042000	1860892000	6012T	
1860161000	1860895000	607589014000	
1860443000	1860898000	6079	
1860703000	1860899000	976554	
1860766000	1860901000	D86	
1860771000	1860905000	FACOMD86	
1860845000	1860905010	KM571A	
1860846000	1860932000	MOT.582-01	

### CODICE MOTORE

DHX	175 A3.000	185 A6.000
DJY	176 A3.000	188 A3.000
DW10UTED4	176 A5.000	188A5.000
D19AA	176 B3.000	192 A1.000
D8B	176B9.000	192 A3.000
D9B	182 A1.000	323.01
LFW	182 A2.000	323.10
RFU	182 A3.000	324.01
RFV	182 A4.000	4HP
RFW	182 A5.000	4HR
RGX	182 A6.000	4HS
RHK	182 A7.000	4HT
RHR	182 A8.000	672.04
RHV	182 B4.000	673.01
162.01	182 B6.000	8140.43S
175 A1.000	182B2.000	836 A3.000

## 54212

0.90 5 10 240

KIT DI ATTREZZI DI CRONOMETRAGGIO DEL MOTORE PER FIAT/LANCIA 1,4 12V



### MODELLO

1,4 12V

### UTENSILI OEM

1 860 899 000  
1 860 901 000

### CODICE MOTORE

182A3.000  
182A5.000  
840A2.000  
840A4.000

## 54215

1.20 5 10 240

KIT DI ATTREZZI DI CRONOMETRAGGIO DEL MOTORE PER ALFA ROMEO/FIAT 1.4 MULTI AIR



### MODELLO

ALFA ROMEO GIULIETTA, MITO  
FIAT PUNTO, PUNTO EVO 1.4 (TURBO) MULTI AIR

### UTENSILI OEM

1860987000  
2000004500  
2000034400

### CODICE MOTORE

940A2.000  
955A2.000  
955A6.000  
955A7.000  
955A8.000

## 54216

1.75 - 5 135

KIT DI ATTREZZI DI CRONOMETRAGGIO DEL MOTORE PER FIAT/OPEL/ALFA 1,9, 2,4L 16V



### MODELLO

ALFA ROMEO 1.9-2.4L DIESEL  
FIAT 1.9-2.4L DIESEL  
OPEL 1.9

### UTENSILI OEM

EN-46788 1.860.898.000  
EN-46789 1.860.905.000  
KM 6130 1.860.905.010  
KM 6349 1.870.896.900

### CODICE MOTORE

Z19DT	192A5.000	362.02
Z19DTH	192A8.000	371.01
Z19DTJ	192A9.000	839A6.000
182B4.000	192B1.000	841C.000
182B9.000	192B4.000	937A2.000
185A6.000	192B5.000	937A3.000
186A6.000	198A2.000	937A4.000
186A8.000	198A3.000	937A5.000
186A9.000	198A6.000	939A1.000
188A2.000	199A5.000	939A2.000
188A7.000	223A7.000	939A3.000
188B2.000	323.02	939A7.000
192A1.000	325.01	939A8.000
192A3.000	342.02	

## 53259

2.75 - 5 135

KIT DI ATTREZZI PER MONTAGGIO/FISSAGGIO MOTORI BMW N42, N46 1.8, 2.0 CON TRASMISSIONE A CATENA



### MODELLO

X1 XDRIVE18I (E84) 2010-2012  
X3 XDRIVE 20I (E83) 2005-2010  
Z4 2.0 (E85/E86) 2004-2009  
1 SERIES 118I, 120I (E81/82/87/88) 2004-2014  
3 SERIES 318I/ 318TI COMPACT (E46) 2001-2007  
3 SERIES 318I, 320I (E90/91/92/93) 2005-2014  
5 SERIES 520I (E60/E61) 2007-2010

### UTENSILI OEM

112300	119340A	LRT12108
115120	119341	LRT12171
119190	119350	KM-6349
119291/3	119350/351	
119292	119351	
119293	12108	
119340	12171	
119340/341	KM813	

### CODICE MOTORE

N42B18A	N46B18A	N46TB20B
N42B20	N46B20	N46TB20BD
N42B20A	N46B20B	N46TB20BZ
N46B18	N46TB20	N46TB20O2

## 54430

 1.00  5  10  240

KIT DI MESSA IN FASE PER ALFA  
ROMEO/FIAT/LANCIA 0.9 TWIN AIR

**MODELLO**

ALFA ROMEO: MITO (2001-2018)

CHRYSLER: YPSILON (2011-2015)

FIAT: 500/500C (2010-2020), 500L/500L LIVING/500L  
MPW (2012-2018), PUNTO (2012-2018), PANDA (2012- )

LANCIA: YPSILON (2011-2018)

**UTENSILI OEM**

2 000 035 100

2 000 035 200

2 000 035 300

**CODICE MOTORE**

199B6.000

199B7.000

312A2.000

312A4.000

312A5.000

312A6.000

## 54444

 2.20  -  2  48

KIT FASATURA MOTORE BENZINA  
BMW M3 -S54

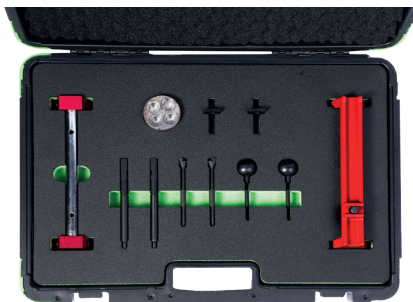
**MODELLO**

BMW M3 CABRIOLET 2000-2006, M3 SPORTS COUPE

1999-2006, M3 CSL SPORTS COUPE 2003-2004

BMW M3 CABRIOLET 2000-2006, M3 SPORTS COUPE 1999-

2006, M3 CSL SPORTS COUPE 2003-2004

FOR PLUS Z3 (M) E36 2000 ONWARDS, Z4 (M) E85/E86

2006 ONWARDS

**UTENSILI OEM**

112300

117160

117342

119130

119140

119170

**CODICE MOTORE**

S50B30

S50B32

S54B32

## 54445

 3.60  -  5  -

BMW M3 S65 KIT DI BLOCCO  
MOTORE A BENZINA

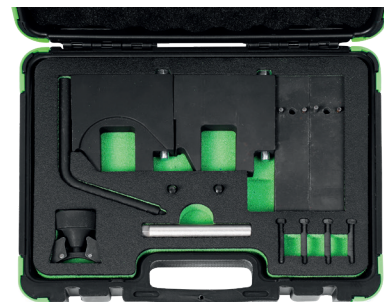
**MODELLO**

BMW E90 M3 &amp; E92 M3 S65 ENGINE (2007-2013)

**UTENSILI OEM**

115 290

115 320

115 370

119 970

**CODICE MOTORE**

S65B40A

## 54441

 3.00  -  2  48

SET DI MESSA A PUNTO DEL MOTORE BMW N47/N57

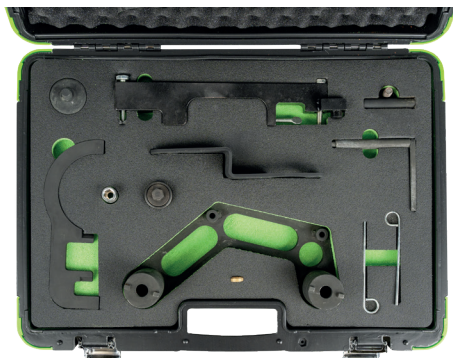
**MODELLO**

BMW SERIE 1,2,3,4,5,6,7, X1,X3,X4,X5,X6

MINI CLUBMAN, MINI, COUPE, ROADSTER, COUNTRY-  
MAN, PACEMAN**UTENSILI OEM**

113340

114320

115320

116480

118740

118741

118750

118760

118790

**CODICE MOTORE**

N47 C16A

N47 C20A

N47 D16A

N47 D16C

N47 D20A

N47 D20B

N47 D20C

N47 D20D

N57 D30A

N57 D30B

N57 D30C

N57 D30D

N57 D30TO

N57 D30UO



## 53260

1 5.60 - 2 48

KIT DI ATTREZZI PER MONTAGGIO/  
FISSAGGIO MOTORI A BENZINA  
BMW N43 1,6/2,0 CON  
TRASMISSIONE A CAT



### MODELLO

1 SERIES 116I,118I,120I (E81/82/87/88) 2007-2014  
3 SERIES 318I,320I (E90/91/92/93) 2007-2014  
5 SERIES 520I (E60/61) 2007-2014

### UTENSILI OEM

113340	119341
115120	119342
118690	8692/11
118691/11	8693
118700	8712
118710	
118711/11	
119340	

### CODICE MOTORE

N43B16A  
N43B16AA  
N43B16OO  
N43B20A  
N43B20AA  
N43B20AY  
N43B20KO  
N43B20UO

## 53261

1 5.20 - 2 40

KIT DI ATTREZZI PER FISSAGGIO  
BMW N42, N46 1.8, 2.0

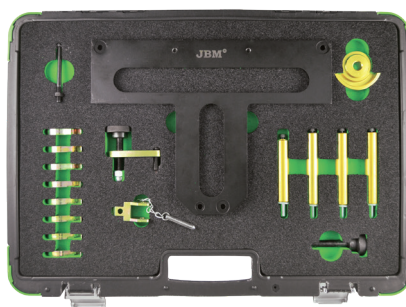

### MODELLO

X1 XDRIVE18I (E84) 2010-2012  
X3 XDRIVE 20I (E83) 2005-2010  
Z4 2.0 (E85/E86) 2004-2009  
1 SERIES 118I/120I (E81/82/87/88) 2004-2014  
3 SERIES 318I/318TI COMPACT (E46) 001-2007  
3 SERIES 318I/320I (E90/91/92/93) 2005-2014  
5 SERIES 520I (E60/E61) 2007-2010

### UTENSILI OEM

119302  
119303  
119310  
119320  
119390

### CODICE MOTORE

N42B18A	N46TB20
N42B20A	N46TB20B
N46B18	N46TB20BD
N46B20	N46TB20BZ
N46B20B	N46TB20O2
N46TB202	

## 53262

1 4.60 - 2 40

KIT DI ATTREZZI DI REGOLAZIONE  
ALBERO A CAMME PER BMW M52TU,  
M54, M56 CON SISTEMA DOUBLE  
VANOS



### MODELLO

X3 2.5, 3.0 (E83) 2003-2007  
X5 3.0 (E53) 1999-2007  
Z3 2.0, 2.2, 2.8, 3.0 (E36) 1999-2003  
Z4 2.2, 2.5, 3.0 (E85/86) 2003-2006  
3 SERIES 320I, 323I, 325I, 325TI, 328I, 330I (E46) 1998-2007  
5 SERIES 520I, 523I, 525I, 528I, 530I (E39) 1998-2003  
5 SERIES 520I, 525I, 530I (E60/61) 2003-2005  
7 SERIES 728I (E38) 1998-2002  
7 SERIES 730I (E65/66) 2002-2005

### UTENSILI OEM

KM823	113450
LRT12114	116150
LRT12222	116180
113292	12114
113390	12222
113390/11	

### CODICE MOTORE

M52B20	226S1
M52B25	256S4
M52B28	256S5
M54	286S2
M54B25	306S3
M54B30	
M56	
206S4	

## 53264

1 4.65 - 2 40

KIT DI ATTREZZI PER FISSAGGIO E REGOLAZIONE ALBERO A CAMME PER BMW N62, N73



### MODELLO

X5 X5 4,4 (E53) 1999-2007  
X5 X5 4,4, XDRIVE 48I (E70) 2006-2013  
5 SERIES 540I, 545I, 550I (E60/61) 2003-2010  
6 SERIES 645I, 650I (E63/64) 2003-2011  
7 SERIES 735I, 740I, 745I, 750I, 760I (E65/66) 2002-2008

### UTENSILI OEM

119190  
119340  
119461  
119462  
119463

### CODICE MOTORE

N62  
N62B36A  
N62B40A  
N62B44A  
N62B48A  
N62B48B  
N62TU  
N73  
N73B60A

## 53263

 1.80  -  5  165

KIT DI ATTREZZI DI REGOLAZIONE ALBERO A CAMME PER  
BMW M47 LAND ROVER TD4,TD6



## MODELLO

BMW X3 2.0D, 3.0D/SD, XDRIVE 30D, XDRIVE 35D (E83) 2003-2010
BMW X5 3.0 D TURBO (E53) 2003 - 2007
BMW X5 3.0 SD, XDRIVE 30D, XDRIVE 35D (E70) 2006-2010
BMW X6 XDRIVE 30D, XDRIVE 35D (E71) 2008-2010
BMW 1 SERIES 118D, 120D (E81/82/87/88) 2004-2007
BMW 3 SERIES 318D, 318TD, 320D, 320TD, 330D (E46) 1998-2007
BMW 3 SERIES 318D, 320D, 325D, 330D, 335D (E90/91/92/93) 2005-2013
BMW 5 SERIES 520D, 525D, 530D (E39) 1998-2003
BMW 5 SERIES 520D, 525D/XD/XDRIVE, 530D, 535D (E60/61) 2003-2010
BMW 6 SERIES 635D (E63/64) 2007-2011
BMW 7 SERIES 730D (E38) 1998-2002
BMW 7 SERIES 730D (E65/66) 2002-2008
LAND ROVER FREELANDER (L314) 2000-2006
LAND ROVER RANGE ROVER (L322) 2002-2006
MG ZT/ZT-T 2001-2005
ROVER 75 1999-2005

## UTENSILI OEM

KM813	116320
LRT12108	116321
LRT12171	116322
LRT12173	12108
112300	12171
115120	12173

## CODICE MOTORE

M47	204D1
M47R	204D3/TD4
M47TU	256D1
M47T2	306D1
M57	306D1/TD6
M57TU	306D2

## 53266

 6.30  -  2  42

KIT DI ATTREZZI DI REGOLAZIONE CINGHIA DENTATA PER  
BMW M42, M43, M50, M51, M52

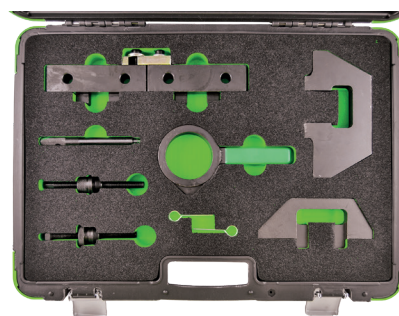

## MODELLO

BMW Z3 1.9 1996-1999
BMW Z3 1.9 1999-2003
BMW 316 1.6 E36 COMPACT 1994-2001
BMW 316 1.6 E36 1993-1999
BMW 316 1.6 E46 1998-2004
BMW 316 1.6 E46 1999-2001
BMW 318 1.8 E30 16V 1989-1991
BMW 318 1.8 E36 S/COUPE 1992-1998
BMW 318 1.8 E36 S/COUPE 1996-1999
BMW 318 1.8 E36 TI COMPACT 1996-2001
BMW 318 1.8 E36 TI 1994-1998
BMW 318 1.8 E36 1993-1999
BMW 318 1.8 E46 1998-2004
BMW 320 2.0 E36 24V 1991-1997
BMW 325 2.5 E36 24V 1991-1997
BMW 518 1.8 E34 1994-1996
BMW 520 2.0 E34 24V 1989-1996
BMW 525 2.5 E34 24V 1989-1996
BMW 535 3.5 E39 1996-2000
BMW 540 4.0 E39 1996-2000
BMW 735 3.5 E38 1996-2002
BMW 740 4.0 E38 1996-2002
BMW 750 5.0 E32/38 1987-2002
BMW 840 4.0 E31 1993-1999
BMW 850 5.0 E31 1990-1999

## UTENSILI OEM

KM 813	113320
KM811	113390
KM823	114220
LRT12108	115120
LRT12112	115490
LRT12114	12108
LRT12171	12112
10171	12114
112300	12171
113190	
113240	
113292	

## CODICE MOTORE

M42	206S1
M43	206S2
M50	206S3
M50B20	256S1
M50B25	256S2
M51	256S3
M52	286S1
M52B20	
M52B25	
M52B28	

## 53265

 5.45  -  2  48

KIT DI ATTREZZI PER FISSAGGIO E REGOLAZIONE ALBERO A CAMME PER BMW DIESEL M47, M57, M41, M51

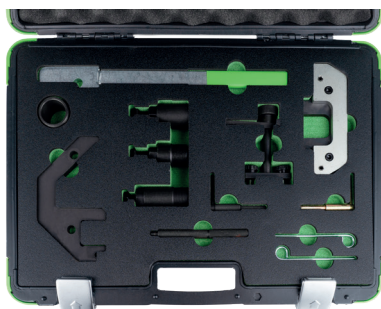

## MODELLO

BMW X3 E83 2004-UP
BMW X5 E53 2000-UP
BMW X5 E70 2007-UP
BMW X6 E71,E72 2008-UP
BMW 1 SERIES 118D, 120D, E87 2003-UP
BMW 3 SERIES 318/320/330 E46 1998-U, 318/320/325/330/335 E90, E91 2005-UP
BMW 5 SERIES 520/525/530 E39 1998, 520, 525, 530, 535 E60, E61 2004-UP
BMW 6 SERIES 635 E63, E64 2007-UP
BMW 7 SERIES 730 E38 1998-UP
BMW7 SERIES 730 E65, E66 2004-2008

## UTENSILI OEM

112300	116322
113340	135190
116320	135191
116321	135192

## CODICE MOTORE

M41	M57T2
M47	X25DT
M47R	204D3
M47TU	256T
M47T2	306D1
M51	
M57	
M57TU	

## 53267

8.00 - 2 40

KIT DI ATTREZZI DI REGOLAZIONE CINGHIA DENTATA PER BMW M40, M43, M42, M44, M52, M54, M56

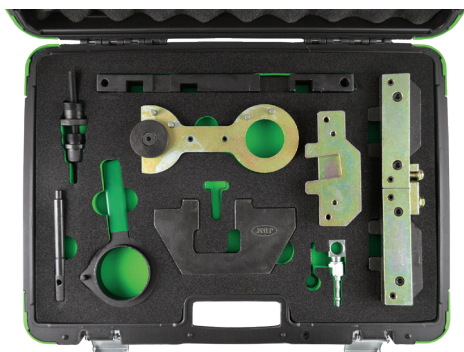

### MODELLO

BMW Z3 1.9 1996-1999
BMW Z3 1.9 1999-2003
BMW 316 1.6 E36 COMPACT 1994-2001
BMW 316 1.6 E36 1993-1999
BMW 316 1.6 E46 1998-2004
BMW 316 1.6 E46 1999-2001
BMW 318 1.8 E30 16V 1989-1991
BMW 318 1.8 E36 S/COUPE 1992-1998
BMW 318 1.8 E36 S/COUPE 1996-1999
BMW 318 1.8 E36 TI COMPACT 1996-2001
BMW 318 1.8 E36 TI 1994-1998
BMW 318 1.8 E36 1993-1999
BMW 318 1.8 E46 1998-2004
BMW 320 2.0 E36 24V 1991-1997
BMW 325 2.5 E36 24V 1991-1997
BMW 518 1.8 E34 1994-1996
BMW 520 2.0 E34 24V 1989-1996
BMW 525 2.5 E34 24V 1989-1996
BMW 535 3.5 E39 1996-2000
BMW 540 4.0 E39 1996-2000
BMW 735 3.5 E38 1996-2002
BMW 740 4.0 E38 1996-2002
BMW 750 5.0 E32/38 1987-2002
BMW 840 4.0 E31 1993-1999
BMW 850 5.0 E31 1990-1999

### UTENSILI OEM

112300	113450
113190	114220
113240	115490
113290	116180
113291	
113292	

### CODICE MOTORE

M40B16	M52B28TU
M42B18	M54B22
M43	M54B25
M43B16	M54B30
M43B18	M56
M43TU819UL	
M44B19	
M50B20	
M50B20TU	
M50B25	
M50B25TU	
M52B20	
M52B20TU	
M52B25	
M52B25TU	
M52B28	

## 54293

0.40 - 20 -

SUPPORTO CONTROLBERO MOTORE PER BMW



### MODELLO

20D XDRIVE (2009-2015), 23D XDRIVE (2009-2012) BMW X3 E83: 2.0D (2007-2008), 18D XDRIVE (2008-2010) BMW X5 E70: 3.0D XDRIVE (2010-2013), 40D (2010-2013) BMW X6 E71/71: 30D XDRIVE (2010-2014), 40D XDRIVE (2010-2014)  
BMW 1 SERIES E81/82/87/88: 116D (2008-2012), 118D (2007-2012), 120D (2007-2014), 123D (2007-2014) BMW 1 SERIES F22: 218D (2011-2014), 220D (2011-2014), 225D (2011-2014) BMW 3 SERIES E90/91/92/93: 316D (2007-2012), 318D (2007-2014), 320D (2007-2012), M550D XDRIVE (2012-2015) BMW 5 SERIES F07: 535D GT (2009-2015) BMW 7 SERIES F01/02/04: 730D (2008-2012), 740D (2009-2012), 750D XDRIVE (2012-2015) BMW X1 E84: 18D SDRIVE (2009-2015), 20D SDRIVE (2009-2015), 18D XDRIVE (2009-2015), 325D (2010-2012), 330D (2008-2014) BMW 5 SERIES E60/61: 520D (2007-2010) BMW 5 SERIES F10/11: 525D (2010-2013), 530D (2010-2013), 530D XDRIVE (2011-2015), 535D (2010-2013), 535D XDRIVE (2011-2015),

### UTENSILI OEM

114320

### CODICE MOTORE

D20A	D20U1	D30O1
D20A/KO	D30A	D30TO
D20B	D30A/OO	D30UO
D20B/TO	D30A0/OO	N47
D20C	D30A0/O1	N47D20C
D20K1	D30B	N47D20D
D20O0	D30B/T1	N57
D20O1	D30C	
D20T0	D30C/S1	
D20U0	D30O0	

## 53269

1.25 - 5 - 10 - 240

KIT DI ATTREZZI DI REGOLAZIONE CINGHIA DENTATA PER BMW N47, N47S, N57 (DA UTILIZZARE CON 54293)



### MODELLO

BMW SERIES 1, 2, 3, 5, 7, X, MINI

### UTENSILI OEM

115320
116480
118740
118760

### CODICE MOTORE

N47C16AU1	N47D16
N47C16K1	N47D16C
N47C16U1	N47D20A
N47C20A/K1	N47D20AKO
N47C20K1	N47D20A/OO
N47C20U1	N47D20C

N47D20C/O	N57D30A/O1
N47D20C/O1	N57D30A0/OO
N47D20D	N57D30B
N47D20O0	N57D30B/TO
N47D20O1	N57D30B/T1
N47D20U0	N57D30C
N47SD20BD	N57D30O0
N47SD20D/TO	N57D30O1
N47TD20K1	N57D30TO
N47TD20O1	N57D30TO
N47TD20U1	N57D30UO
N57D30	N57D30UO
N57D30A	
N57D30A/OO	

## 54219

1.09 - 5 135

KIT DI STRUMENTI DI  
CRONOMETRAGGIO DEL MOTORE  
PER BMW/MINI/CITROËN/  
PEUGEOT



## MODELLO

BMW 1.6, 1.8, 2.0, 3.0

MINI 1.4, 1.6

PSA 1.4, 1.6 16V

## UTENSILI OEM

113340

114360

115140

119280

119330

## CODICE MOTORE

B16 N42

B16A N45

B16AC N45T

EP3 N46

EP6 N46T

EP6DT N51

EP6DTS N52

N12 N53

N14 N54

N40

## 54222

1.40 5 10 240

KIT DI ATTREZZI DI  
CRONOMETRAGGIO DEL MOTORE  
MINI 1.6



## MODELLO

CITROËN: DS3 2006-2010, C4 2006-2010, GRAND

PICASSO 2006-2010

MINI: COOPER S 2007-2010

PEUGEOT: 207 2006-2010, 307 2006-2010, GT 2006-2010, THP 2006-2010, GTI 2006-2010

## UTENSILI OEM

119550

119551

119552

119590

## CODICE MOTORE

N14 B16A

N14 B16CD

N14 B16TO

## 54228

5.15 - 2 48

KIT DI ATTREZZI DI  
CRONOMETRAGGIO DEL MOTORE  
PER BMW/MINI 1.2, 1.5, 2.0, 3.0



## MODELLO

BMW 1.5, 1.6, 2.0, 3.0

MINI 1.2, 1.5, 2.0

## UTENSILI OEM

11 4 120

2 288 380

2 357 904

2 358 122

2 365 488

2 456 372

## CODICE MOTORE

B36 A15A B48 A20B

B38 A12A B48 A20E

B38 A15A B48 B16A

B38 A15A B48 B20A

B38 B15A B48 B20B

B38 K15A B58 B30A

B46 B20A B58 B30B

B48 A20A B58 B30C

## 54227

2.40 - 5 120

KIT DI ATTREZZI DI CRONOMETRAGGIO DEL MOTORE BMW/MINI N13, N18



## MODELLO

BMW MINI

CITROËN PSA

## UTENSILI OEM

EN-52127-2 0197 A31 0197-N

EN-52588 0197-A1 11 7 440

E1 100 0197-A1Z 11 9 340

G 1376A 0197-A11 11 9 540

T10550/2 0197A2 11 9 551

T10550/3 0197-A31 11 9 590

O 496 709 0197-A32 1376-A

0109 2B 0197-A33 2 299 362

0197 A11 0197-BZ

0197 A3 0197-M

## UTENSILI OEM

EP3 EP6FDTM 5FH 5FY

EP3C EP6FDTX 5FK 5GF

EP6 N12 B14A 5FL 5GG

EP6C N13 B16A 5FM 5GM

EP6CDT N14 B16A 5FN 5GN

EP6CDTM N14 B16C 5FP 5GP

EP6CDTR N16 B16A 5FR 5GR

EP6CDTX N18 B16A 5FS 5GT

EP6DT N18 B16C 5FS (EP6C) 5GW

EP6DTE 5FA 5FT 5GY

EP6DTS 5FD 5FU 5GZ

EP6FADTX 5FE 5FV 8FN

EP6FADTXD 5FF 5FW 8FP

EP6FDT 5FG 5FX 8FR

8FS

## 54206

1.75 5 150

KIT DI ATTREZZI DI CRONOMETRAGGIO DEL MOTORE PER BMW/MINI 1.5, 2.0L

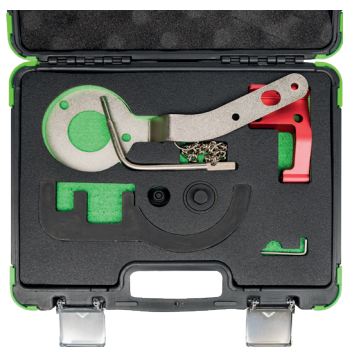

### MODELLO

BMW SERIES 1, 2, 3, 4, 5, X1, X3, X4, X5,  
MINI CLUBMAN, ONE D, COOPER D/SD MINI HATCH

### UTENSILI OEM

11 4 120  
11 8 030  
11 8 740  
11 8 76  
2 288 380  
2 347 904  
2 365 488

### CODICE MOTORE

B37 C15A  
B37 D15A  
B47 C20A  
B47 C20B  
B47 D20A  
B47 D20B

## 54398

1.00 5 10 240

SET DI BLOCCAGGIO DELLA PULEGGIA DELL'ALBERO MOTORE/ DEL VOLANO PER BMW/MINI



### MODELLO

MINI HATCH (14-21), CABRIOLET (16-19), CLUBMAN (15-19), COUNTRYMAN (17-19)

### UTENSILI OEM

11 4 180  
11 6 480  
11 9 265  
11 9 810  
11 9 811

### CODICE MOTORE

B37	125d	425d
B38	214d	430i
B47	216d	440i
B48	216i	518d
i8	218d	525d
M140i	218i	530i
M240i	220d	540i
X1	225d	620d
X2	316d	630i
X3	318i	640i
X4	320d	725d
X5	325d	730i
116d	330i	740i
116i	340i	
118d	418i	
120d	420d	

## 54399

5.00 5 120

KIT DI MESSA IN FASE PER BMW/RANGE ROVER/OPEL 2.5D



### MODELLO

BMW: 318TDS (94-00), 325TD (91-99), 325TDS (91-99), 525TD (90-03), 525TDS (90-03), 725TDS (95-02)  
RANGE ROVER: P38 (94-02)  
VAUXHALL/OPEL: OMEGA-B (94-01)

### UTENSILI OEM

KM811  
KM813  
KM822  
KM823  
112300  
113320  
113340  
113360  
115120  
12108  
12112  
12115  
12-172

### CODICE MOTORE

M41/174T1  
M51/256T1  
X25DT  
25DT  
256T

## 54400

6.65 2 44

KIT DI MESSA IN FASE PER BMW N20, N26



### MODELLO

BMW: 1 SERIES 125i - F20/21 (2012-2016) 2 SERIES COUPE 220i, 228i - F22 (2014-2016) 2 SERIES CABRIOLET 220i 228i - F23 (2015-2016) 3 SERIES 320i 328i XDRIVE - F30/31 (2012-2015) 3 SERIES GRAN TURISMO 320i, 328i XDRIVE - F34 (2013-2016)  
X4 XDRIVE20i, 28i (F26) 2014 - 2018, X5 XDRIVE40E (F15) 2015 - 2018, Z4 SDRIVE18i, 20i, 28i (E89) 2011 - 2017  
4 SERIES COUPE 420i, 428i/XDRIVE - F32(2013-2016), 4 SERIES CABRIOLET 420i, 428i/XDRIVE-F33 (2014-2016) 4 SERIES GRAN COUPE 420i, 428i/XDRIVE F36 (2014-2016)  
5 SERIES 520i, 528i/XDRIVE(F10/11) 2010 - 2017, 5 SERIES GRAN TURISMO 528i-(F07) 2013 - 2016, X1 SDRIVE16i, 18i, 20i, XDRIVE20i, 28i-(E84) 2011 - 2015, X3 SDRIVE18i, 20i, XDRIVE20i, 28i (F25) 2011 - 2017

### UTENSILI OEM

11 9 340A	2 212 830
11 9 341	2 212 831
11 9 340/341	2 219 548
119340	

### CODICE MOTORE

B16A	N20
B20	N20B/UO
B20A	N26
B20B	
B2000	
B26	

## 54401

 2.60  -  5  135

KIT DI MESSA IN FASE PER BMW/  
MINI N13, N18



### MODELLO

BMW 114i (2012-2015)  
BMW 116i (2012-2015)  
BMW 118i (2011-2015)  
BMW 316i (2012-2015)  
MINI CLUBMAN (R55) (2011-2014)  
MINI COOPER S (R56/57) (2010-2015)  
MINI COUNTRYMAN (R60) (2012-2016)  
MINI COUPE COOPER S (R58) (2012-2015)  
MINI PACEMAN (R61) (2013-2017)  
MINI ROADSTER (R59) (2012-2015)

### UTENSILI OEM

11-7-440  
11-9-340  
119-590  
496-709

### CODICE MOTORE

N13 B16A  
N18 B16A  
N18 B16/M0  
N18B16A/M0  
N18B16C  
N18B16C/TO  
N18B16M0

## 54402

 915  -  2  44

KIT DI MESSA IN FASE PER BMW N51, N52, N53, N54, N55



### MODELLO

X1 XDRIVE25I, XDRIVE28I (E84) 2009-2011  
X3 SI, XDRIVE25I, XDRIVE30I (E83) 2006-2010  
X3 XDRIVE28I (F25) 2011-2017  
X4 XDRIVE35I, M40IX (F26) 2014-2018  
X5 SI, XDRIVE30I (E70) 2006-2013  
X5 XDRIVE35I (F15) 2013-2018  
X6 XDRIVE35I (E71) 2008-2014  
X6 XDRIVE35I (F16) 2015-2019  
Z4 SDRIVE23I, SDRIVE30I, SDRIVE35I (E89) 2009-2017  
Z4 SI (E85/86) 2006-2009  
1 SERIES M135I/XDRIVE (F20) 2012-2016  
1 SERIES 125I, 130I, 135I, M COUPE (E81/82/87/88)  
2005-2014  
2 SERIES M235I/XDRIVE, M2 (F22/23)(F87) 2014-ON  
3 SERIES 323I, 325I, 330I, 335I (E90/91/92/93) 2005-2014  
3 SERIES 335I/XDRIVE, M3 (F30/31/34)(F80) 2012-2019  
4 SERIES 435I/XDRIVE, M4 (F32/33/36)(F82/83) 2013-2020  
5 SERIES 523I, 525I, 530I, XI/XDRIVE (E60/61) 2005-2010  
5 SERIES 523I, 528I, 530I (F10/11) 2010-2017  
6 SERIES 630I (E63/64) 2004-2011  
6 SERIES 640I/XDRIVE (F12/13/06) 2011-2018  
7 SERIES 730I (E65/66) 2005-2008  
7 SERIES 730I, 740I (F01/02/04) 2008-2015

### UTENSILI OEM

110300  
114280  
114281  
114282  
114283  
114285  
114290  
118520  
119340  
119340A  
119341

### CODICE MOTORE

N51 B30A  
N52 B25A  
N52 B25AE  
N52 B25AF  
N52 B30A  
N52 B30AF  
N53 B25A  
N53 B30A  
N54 B30A  
N55 B30A  
S55 B30A

## 54403

 8.25  -  2  44

KIT DI MESSA IN FASE PER BMW / LAND ROVER



### MODELLO

BMW 5 SERIES: 530I, 540I (E34) (1992-1996), 535I, 540I (E39) (1996-2003)  
BMW 7 SERIES: 730I, 735I, 740I (E38) (1994-2002), 730I, 740I (E32) (1992-1994)  
BMW 8 SERIES: 840I (E31) (1993-1999)  
LAND ROVER/RANGE ROVER: (L322) (2002-2005)  
X5: 4.4, 4.6 (E53) (1999-2004)

### UTENSILI OEM

M60 B30	M62 TUB44	44 8S 1
M60 B40	V8/44 8S 2	44 8S 2
M62 B35	30 8S 1	46 8S 1
M62 B44	35 8S 1	
M62 B46	35 8S 2	
M62 TUB35	40 8S 1	

### UTENSILI OEM

KM 813	LRT 12 228/1	11 5 120	12 222
LRT 12 108	LRT 12 228/2	11 5 180	12 223/1
LRT 12 171	LRT 12-223/1	11 6 420	12 223/3
LRT 12 220	11 2 300	11 6 440	12 223/4
LRT 12 221	11 2 441	11 6 452	12 224
LRT 12 222	11 2 441/445	11 7 380	12 226
LRT -12 223/2	11 2 442	113390/117380	12 227
LRT 12 223/3	11 2 442/446	116451	12 228/1
LRT 12 223/4	11 2 445	12 108	12 228/2
LRT 12 224	11 2 446	12 171	
LRT 12 226	11 3 310	12 220	
LRT 12 227	11 3 390	12 221	

## 54404

5.50 - 2 44

KIT DI MESSA IN FASE PER BMW N62, N73



### MODELLO

- X5 X5 4,4 (E53) 1999-2007
- X5 X5 4,4, XDRIVE 48i (E70) 2006-2013
- 5 SERIES 540i, 545i, 550i (E60/61) 2003-2010
- 6 SERIES 645i, 650i (E63/64) 2003-2011
- 7 SERIES 735i, 740i, 745i, 750i, 760i (E65/66) 2002-2008

### UTENSILI OEM

B117270	119453
113460	119454
119190	119461
119340	119462
119451	119463
119452	

### CODICE MOTORE

- N62 B36A
- N62 B40A
- N62 B44A
- N62 B48A
- N62 B48B
- N73 B60A

## 54406

2.50 - 5 135

BLOCCO VOLANTE MOTORE BMW/MINI



### MODELLO

- BMW Z SERIES: Z4 E85/86 (04-09), Z4 (E89) (11-15)
- BMW 1 SERIES: F20/21 (12-15), 116i (04-12), 118i (04-14), 120i (04-14), 130i (05-07), 135i (07-11), 116D (08-12), 118D (04-14), 120D (04-14), 123D (07-14), M COUPE (11-12)
- BMW 3 SERIES: F30/31 (12-15), 316Ti (04-14), 316i (04-11), 316D (09-12), 318i (04-07), 318Ti/COMPACT (04-04)
- BMW 3 SERIES: 318D (03-12), 318TD (03-07), 320D (01-07), 320D COMPACT (01-05), 318i (05-13), 320D (07-14), 320i (05-14), (05-14), 320Si(05-06)
- BMW 3 SERIES: 323i (05-11), 325i (05-14), 325D (06-10), 330D (05-08), 330i (06-13), 335D (05-13), 335i (05-11)
- BMW 4 SERIES: 420i F32 (13-15), 428i F32 (13-15), 420i F33 CABRIOLET (14-15), 428i F33 CABRIOLET (14-15), 420i F36 (14-15), 428i F36 GRAN COUPE (14-15)
- BMW 5 SERIES: F10/11 (10-15), 520D (05-10), 520i (07-10), 523i (03-10), 525D (05-10), 525i (05-10), 525i (07-10), 530D (03-10), 530i (05-10), 535D (04-10)
- BMW 6 SERIES: 630i (04-11), 635D (07-11)
- BMW 7 SERIES: 730D (05-08), 730i (02-08) BMW X SERIES: X1 E84 (09-15), X3 E83 (03-14), X5 E53 (03-14), X3 F25 (11-15), X6 E71/72 (08-10)
- MINI: MINI (03-06)

### UTENSILI OEM

- 11 8 180
- 11 8 181
- 11 8 182
- 11 8 183
- 11 8 184
- 11 8 185

### CODICE MOTORE

- M47T2
- M57T2
- M67
- N43
- N45
- N45T
- N46
- N46T
- N47
- N51
- N52
- N53
- N54
- W17

## 54405

4.20 - 2 48

KIT DI MESSA IN FASE PER BMW N63, N74



### MODELLO

- SERIES 5, SERIES 6, SERIES 7, X5, X6

### UTENSILI OEM

- 11 8 090
- 11 9 190
- 11 9 891
- 11 9 892
- 11 9 893

### CODICE MOTORE

- N63
- N74
- S63



## 54324

0.20 5 50 -

INDICATORE DI USURA DELLA  
CATENA DI DISTRIBUZIONE MINI



## MODELLO

BMW SERIES 1, 2, 3, 4, 5, 6, 7, X1, X2, X3, X4, X5, X6  
MINI: CLUBMAN (2007-2014), CLUBVAN (2012-2014),  
COUNTRYMAN (2010-2017), COUPÉ (2011-2015), MINI  
(2006-2015), PACEMAN (2013-2017), ROADSTER (2012-  
2015)

## UTENSILI OEM

2353281

## CODICE MOTORE

N12 B14  
N13  
N16 B16A  
N16 B16A/MO  
N16 B16KO  
N16 B16MO  
N16 B16UO  
N18  
N18 B16A  
N18 B16A/MO  
N18 B16C  
N18 B16C/TO  
N18 B16MO  
N57  
1.4 N12 B14AB  
1.6 N12 B16A

## 54442

1.00 5 10 -

ALLINEATORE PER ALBERO  
DI BILANCIAMENTO E POMPA  
DELL'OLIO BMW



## MODELLO

BMW X1 (E84)  
BMW X3 (F25)  
BMW X5 (F15)  
BMW Z4 (E89)  
BMW 1 SERIES (F20/F21)  
BMW 2 SERIES (F22/F23)  
BMW 3 SERIES (F30/F31/F34)  
BMW 4 SERIES (F32/F33/F36)  
BMW 5 SERIES (F10/F11)

## UTENSILI OEM

114120  
2212825  
2318117

## CODICE MOTORE

N20B16A  
N20B20  
N20B20A  
N20B20B  
N26B20  
N26B20A

## 54722

0.85 5 10 800

KIT DISTRIBUZIONE E TENDITORE  
DEL MOTORE - PER FORD E PSA  
DIESEL

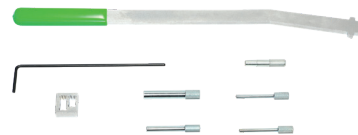

## MODELLO

VAUXHALL / OPEL: COMBO-E (2018 - ON) CROSSLAND  
X (2017-2021) GRANDLAND X (2017-2021) VIVARO - C  
(2019 - ON)

## UTENSILI OEM

01099-B1  
01099-B2  
0188-Q1  
0194-A  
0194-B  
0194-C  
0194-D  
0194-J

## CODICE MOTORE

DV5RC/YHZ (LQP/D15DTH)  
DV5RD/YHY (LQJ/D15DT)  
DV5RE/YHW (LQJ/D15DTL)  
DV5RUCD/YHR  
DV5RUC/YHV  
DV6FC (LDI/B16DTH)  
DV6FC/BHX (LEK/B16DT)  
DV6FE/BHW (LEK/B16DTL)

## 53268

2.60 - 5 150

KIT DI ATTREZZI DI REGOLAZIONE CINGHIA DENTATA PER BMW/MINI/PSA 1.4, 1.6



## MODELLO

BMW MINI  
PSA 1.4, 1.6 16V

## UTENSILI OEM

0197-A1  
0197-A3  
0197-B  
0197-BZ  
115540  
115590  
119340  
119550

## CODICE MOTORE

EP3	N16B16A/MO
EP3C	N16B16A/MO
EP6	N16B16KO
EP6C	N16B16MO
EP6CDT	N16B16UO
EP6DT	5FS
EP6DTS	5FS (EP6C)
N12B14	5FT
N12B14AB	5FV
N14B16A	5FW
N14B16CD	5FX
N14B16CD/TO	5FY
N14B16TO	8FR
N16B16A	8FS



## 54739



STRUMENTO DI BLOCCAGGIO PER LA FASATURA DELL'ALBERO A CAMME DEL MOTORE PSA PEUGEOT CITROËN



### MODELLO

C-ELYSEE (12-15)  
 CITROËN C3 II (12-15)  
 C4 CACTUS (14-15)  
 DS3 (12-15)  
 PEUGEOT 108 (14-15)  
 PEUGEOT 2008 (13-15)  
 PEUGEOT 208 (12-15)  
 PEUGEOT 308 (13-15)  
 PSA 1,0,1,2 CTI  
 VAUXHALL/OPEL 1.0L, 1.2L 3-CYLINDER

### UTENSILI OEM

J-0109-2C  
 J-0109-2D  
 0109 2A  
 0197-N  
 52127101092B  
 52127-2

### CODICE MOTORE

EBO(ZMZ)  
 EB2D(HMT)  
 EB2F(HMZ)  
 EB2(HMZ)  
 HMY(EB2M)  
 HMZ(EB2)  
 ZMZ(EBO)

## 53313



KIT DI ATTREZZI DI REGOLAZIONE CINGHIA DENTATA PER CITROEN/ PEUGEOT

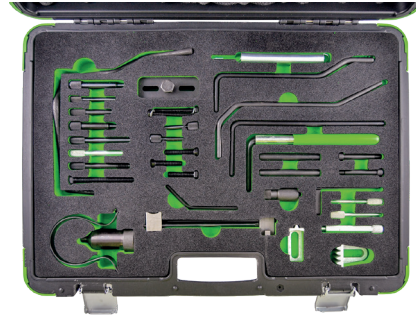

### MODELLO

CITROËN: BERLINGO 2008-2011, C2 2003-2010, C-ELYSEE 2012-2016, C3 PLURIEL 2003-2010, C4 2004-2011, NEMO 2008-2015, XSARA 2000-2005  
 PEUGEOT: 106 1998-2003, 206 1998-2009, 207 2006-2013, 306 1998-2003, 307 2000-2008, 1007 2005-2010, PARTNER 1998-2011, BIPPER 2008-2015

### UTENSILI OEM

EN-52137	077440010400
EN-52141	0991958120
KM-6349	119790
MOT.1430	132Z
MOT1430	1.860.617.000
MOT1436	1870900100
0123-RZ	2000023200
0132AB	21-260
0132AJ1	21263
0132AJ2	3031277
0132AK	303-732
0132Q	303735
0132QY	4200TA
0132QZ	4507TA
0132R	4507TB
0153AA	4527TS2
0153AB	4533TAC
0153AK	4533TAC2
0153AL	4533TAD
0153G	49JE02018
0153ZY	49JE02021
0178D	5711TD
0187B	607589011500
0188K	7014TN
0188M	7099TM
0188Q1	976727
0189B	99360608
0189K	9997122
0194A	9997169
0194B	

### CODICE MOTORE

EC5 (NFP)	NFS (TU5JP4S)
ET3J4 (KFU)	NFU (TU5JP4)
KDX (TU3MC)	TU3A (KFT)
KFT (TU3A)	TU3A (KFV)
KFU (ET3J4)	TU3A (KFW)
KFV (TU3A)	TU3JP (KFV)
KFV (TU3JP)	TU3JP (KFW)
KFW (TU3A)	TU3JP (KFX)
KFW (TU3JP)	TU3M (KDX)
KFX (TU3JP)	TU5JP4 (NFU)
NFP (EC5)	TU5JP4B (NFR)
NFR (TU5JP4B)	

## 53314



KIT DI ATTREZZI DI REGOLAZIONE CINGHIA DENTATA PER CITROEN/ PEUGEOT 1.8, 2.0



### MODELLO

PSA: 1.8 16V, 2.0 16V

### UTENSILI OEM

0132AB  
 0153U  
 0178D  
 0178E  
 0188AH  
 0188J  
 0188JJ2  
 0188J2  
 0188M  
 0189B  
 0189R  
 0189S1  
 0189S2  
 0194A  
 0194B  
 5711TE  
 7017TR

### CODICE MOTORE

EW10ABE4(RFH)  
 EW10A(RFJ)  
 EW10 J4S(RFK)  
 EW7A(6FY)  
 RFH  
 RFJ  
 RFK  
 6FY

**53876**

KIT DI ATTREZZI DI REGOLAZIONE CINGHIA DENTATA PER PSA 1.0, 1.2 VTI

**MODELLO**

CITROËN: BERLINGO III 2014-2018, BERLINGO IV 2018-ON, C1 II 2014-2018, C3 III 2012-2017, C3 IV 2016-ON, C3 PICASSO 2014-2017, C3 AIRCROSS 2017-ON, C4 II 2014-2018, C4 CACTUS 2014-2018, C4 CACTUS 2017-2021, C-ELYSEE 2012-ON, C4 PICASSO/GRAND PICASSO II 201

DS: 3 2015-2016, 3 II 2016-2020, 3 CROSSBACK 2019-ON, 4 2015-2015, 4 II 2015-2019, 4 CROSSBACK 2015-2019, 7 CROSSBACK 2018-ON

PEUGEOT: 108 2014-2018, 208 2012-2019, 208 II 2019-ON, 301 2012-2020, 308 2013-ON, 508 2019-ON, 2008 2013-2020, 2008 II 2020-ON, 3008 2014-2016, 3008 II 2016-ON, 5008 2014-2017, 5008 II 2017-ON, PARTNERIII 2014-2018, PARTNERIV 2018-ON, RIFTER 2018-ON

TOYOTA: AYGO 2015-2018

VAUXHALL/OPEL: COMBO-E 2018-ON, CORSA-F 2019-ON, CROSSLAND X 2017-2021, GRANDLAND X 2017-ON

BMW 2 SERIES (F22/F23)

BMW 3 SERIES (F30/F31/F34)

BMW 4 SERIES (F32/F33/F36)

BMW 5 SERIES (F10/F11)

**UTENSILI OEM**

EN-52127-1	0109 2B
EN-52127-2	0109-2A
EN-52588	0197-N

**CODICE MOTORE**

B12XHT	HMP
D12XHL	HMR
D12XHT	HMT
EBO	HMU
EB0F	HMV
EB2	HMW
EB2ADT	HMX
EB2ADTD	HMY
EB2ADTS	HMZ
EB2ADTX	HM01
EB2D	HNK
EB2DT	HNN
EB2DTM	HNP
EB2DTS	HNS
EB2DTSO	HNW
EB2DTSM	HNW
EB2F	HNX
EB2FA	HNZ
EB2FAD	HN02
EB2FB	HN05
EB2M	HN05
F12XHT	ZMZ
HMH	1PP
HMM	

**54288**

KIT DI MESSA IN FASE PSA 1.2 GDI PURETECH

**MODELLO**

CITROËN: BERLINGO 2014-ON, C3/PICASSO 2012-2017, C3/AIRCROSS 2016-ON, C4/CACTUS 2014-ON, C4 PICASSO/GRAND PICASSOII 2015-2018, C4 SPACETOURER/GRAND SPACETOUREUR 2018-ON, C5 AIRCROSS 2019-ON, DS3/DS3 CABRIO 2013-2015, DS4 2014-2015 DS: DS 3/CROSSBACK 2015-ON, DS 4/CROSSBACK

2015-2019, DS 7/CROSSBACK 2018-2022

PEUGEOT: 208 2012-ON, 308 2013-2021, 508 2019-ON, 2008 2013-ON, 3008 2014-ON, 5008 2014-ON, PARTNER 2014-ON, RIFTER 2018-ON

VAUXHALL/OPEL: COMBO-E 2018-ON, CORSA-F 2019-ON, CROSSLAND X 2017-ON, GRANDLAND X2017-ON

**UTENSILI OEM**

EN-52127-2
EN-52588
J-0109-2C
J-0109-2D
O109-2B
O109-2C
O109-2D
O197-N

**CODICE MOTORE**

B12XHL	EB2FAD
B12XHT	F12XHT
D12XHL	HMR
D12XHT	HMT
EBO	HMU
EB0F	HNJ
EB2ADT	HNK
EB2ADTD	HNL
EB2ADTS	HNN
EB2ADTSM	HNP
EB2ADTX	HNS
EB2ADTXM	HNT
EB2DT	HNW
EB2DTM	HNW
EB2DTS	HNX
EB2DTSO	HNY
EB2DTSM	HNZ
EB2FA	

**54323**

KIT DI ATTREZZI DI REGOLAZIONE CINGHIA DENTATA PER PSA 1.0, 1.2 VTI, 1.2 GDI PURETECH

**MODELLO**

CITROËN: C1 II (2014-2018), C3 III (2012-2017), C3 IV (2016-2018), C4 CACTUS (2014-2020), C4 AIRCROSS (2018-2020), C-ELYSEE (2012-2018), DS3 (2012-2018), BERLINGO IV (2018-2020),

GM: CROSSLAND X (2017-2020), COMBO E (2018-2020), GRANDLAND X (2017-2020)

PEUGEOT: 108 (2014-2018), 208 (2012-2021), 2008 (2013-2021), 301 (2012-2020), 308 (2013-2021), 3008 (2016-2021), 508 (2019-2021), 5008 (2014-2021), PARTNER III (2015-2018), PARTNER IV (2018-2021), RIFTER (2019-2021)

TOYOTA: AYGO (2014-2018).

**UTENSILI OEM**

EN-52127-1
EN-52127-2
G-0109-6
J-0109-2C
J-0109-2D
O109 2B
O109-2A21

**CODICE MOTORE**

B12XHL	HMR
B12XHT	HMT
D12XHL	HMU
D12XHT	HMV
EBO	HMW
EB0F	HMX
EB2	HMY
EB2ADT	HMZ
EB2ADTD	HM01
EB2ADTS	HM05
EB2ADTSM	HNJ
EB2ADTX	HNK
EB2ADTXM	HNL
EB2D	HNN
EB2DT	HNP
EB2DTM	HNS
EB2DTS	HNT
EB2DTSO	HNW
EB2DTSM	HNW
EB2F	HNW
EB2FA	HNX
EB2FAD	HNY
EB2FB	HNZ
EB2FD	HN02
EB2M	HN05
F12XHT	YH01
HMH	ZMZ
HMM	1PP
HMP	

## 16400



CALIBRO CONTROLLO CINGHIA DENTATA PSA (RIF.54288)



### MODELLO

CACTUS (14-20), C4 AIRCROSS (18-20), C-ELYSEE (12-18), DS3 (12-18)  
 CITROËN: BERLINGO IV (18-20), C1 II (14-18), C3 III (12-17), C3 IV (16-18), C4  
 GM: CROSSLAND X (17-20), COMBO E (18-20), GRANDLAND X (17-20)  
 PEUGEOT: 108 (14-18), 208 (12-21), 2008 (13-21), 301 (12-20), 308 (13-21), 3008 (16-21), 508 (19-21), 5008 (14-21), PARTNER III (15-18) PARTNER IV (18-21) RIFTER (19-21)  
 TOYOTA: AYGO (14-18)

### UTENSILI OEM

EN-52809  
 G-0109-6

### CODICE MOTORE

EB2ADJ	HMW EB2
EB2ADS	HMX EB2F
EB2ADT	HMY EB2M
EB2ADTX	HMZ EB2
EB2DT	HMZ EB2D
EB2DTM	HMZ EB2F
EB2DTS	HMZ EB2FB
EB2DTSM	HM01 1PP
EB2F	HNK EB2ADT
EB2FAD	HNN EB2ADTX
EB2FB	HNP EB2ADJ
EB2M	HNS EB2ADS
HMH EB2FAD	HNV EB2DTM
HMM EB2FAD	HNW EB2DTS
HMP EB2FB	HNW EB2DTSM
HMR EB2FA	HNY EB2DTS
HMT EB2D	HNZ EB2DT
HMT EB2F	1PP
HMV EB2M	

## 54433



KIT DI MESSA IN FASE PER PSA 1.0, 1.1, 1.2, 1.4, 1.6, 2.0



### MODELLO

CITROËN: BERLINGO/BERLINGO FIRST I/II 1999 - 2007, C4 2004 - 2011, C4 II 2010 - 2018, C4 PICASSO/GRAND PICASSO 2006 - 2015, C4 PICASSO/GRAND PICASSO II  
 DS: 4 2015, 4 II 2015-2018, 4 CROSSBACK 2015-2018, 5 2015-2018, 7 CROSSBACK 2017-ON  
 FIAT: SCUDDO 1999-2016, ULISSE 1999-2002  
 MITSUBISHI: OUTLANDER 2007-2013  
 PEUGEOT: 206 1999-2006, 306 1999-2002, 307 2001-2008, 307 CC 2005-2009, 308 2007-ON, 308 CC 2009-2015, 406 1999-2004, 407 2004-2011, 407 COUPE 2007-2012, 508 2011-2018, 607 2000-2011, 807 2005-2015, 3008 2009-2016, 3008 2016-ON, 4007 2007-2012, 5008 2009-  
 TOYOTA: PROACE 2013-ON

### UTENSILI OEM

EN-52137	3MM PIN
KM-6349	303 735
MOT. 1430	3031277
MOT 1430	303-732
MOT 1436	4507 TA
M10 X 70MM	4507 TB
0123-RZ	4527 TS2
0132AB	4533 TAD
0132AJ1	49 JE02 018
0132AK	49 JE02 021
0132Q	5711 TD
0132QY	607589011500
0132QZ	7014 TN
0132R	77440010400
0153AA	8MM DRILL BIT
0153AB	8MM PIN
0153AK	9767 27
0153G	99360608
0153ZY	999 7122
0178D	999 7169
0187B	
0188K	
0189B	
0189K	
0194A	
0194B	
09919 58120	
1 870 900 100	
10MM PIN	
11 9 790	
132Z	
1.860.617.000	
21 263	
21-260	

### CODICE MOTORE

AHH (DW10FC)	DW12BTED4 (4HT)
AHJ (DW10FE)	DW12CTED4 (4HL)
AHK (DW10FE)	DW12MTED4 (4HK)
AHM (DW10FUE)	DW12MTED4 (4HN)
AHN (DW10FUD)	DW12RUC (4HC)
AHP (DW10FUC)	DW12RUD (4HB)
AHR (DW10FD)	DW12RUE (4HA)
AHS (DW10FD)	DW12TED4/L4 (4HW)
AHV (DW10FD)	DW12UTED (4HY)
AHW (DW10FC)	EHZ (DW10FC)
AHX (DW10FD)	RHB (DW10CTED4)
AHY (DW10CE)	RHC (DW10CTED4)
AHZ (DW10CTED4)	RHD (DW10C)
DW10ATED (RHS)	RHD (DW10CTED4)
DW10ATED (RHX)	RHE (DW10CTED4)
DW10ATED (RHZ)	RHF (DW10BTED4)
DW10ATED4 (RHM)	RHG (DW10UTED4)
DW10ATED4 (RHW)	RHH (DW10C)
DW10ATED4/L4 (RHT)	RHH (DW10CTED4)
DW10BTED (RHX)	RHJ (DW10BTED4)
DW10BTED4 (RHF)	RHK (DW10UTED4)
DW10BTED4 (RHL)	RHL (DW10BTED4)
DW10BTED4 (RHR)	RHM (DW10ATED4)
DW10CD (AHZ)	RHR (DW10BTED4)
DW10CE (AHY)	RHS (DW10ATED)
DW10CTED4 (RHC)	RHT (DW10ATED4/L4)
DW10CTED4 (RHD)	RHV (DW10UTD)
DW10CTED4 (RHE)	RHW (DW10ATED4)
DW10CTED4 (RHH)	RHW (DW10JATED4)
DW10FC (AHH)	RHX (DW10BTED/L3)
DW10FC (AHT)	RHY (DW10TD)
DW10FC (AHW)	RHZ (DW10ATED)
DW10FC (EHZ)	RHZ (DW10ATED/L3)
DW10FD (AHR)	RHZ (DW10ATED4)
DW10FD (AHS)	RH02 (DW10CTED4)
DW10FD (AHV)	4HK
DW10FD (AHX)	4HK (DW12MTED4)
DW10FE (AHJ)	4HL (DW12CTED4)
DW10FE (AHK)	4HN
DW10FUC (AHP)	4HN (DW12MTED4)
DW10FUD (AHN)	4HP (DW12BTED4)
DW10FUE (AHM)	4HR (DW12BTED4)
DW10TD (RHY)	4HS (DW12BTED4)
DW10UTD (RHV)	4HT (DW12BTED4)
DW10UTED4 (RHG)	4HW (DW12TED4/L4)
DW10UTED4 (RHK)	4HX (DW12TED4)
DW12ATED (4HX)	4WZ-FHV/DW10FC (AHW)
DW12ATED (4HZ)	4WZ-FTV/DW10FD (AHX)
DW12BTED4 (4HP)	4WZ-FTV/DW10FE (AHJ)
DW12BTED4 (4HR)	4WZ-FTV/DW10FE (AHK)
DW12BTED4 (4HS)	

## 54432



KIT DI MESSA IN FASE PER PSA 2.7,  
3.0 HDI



## MODELLO

CITROËN: C5 III 2007-2014, C6 2005-2009

JAGUAR: S-TYPE 2004-2008, XF 2008-2020, XJ 2010-2020, XJ6 2005-2010, F-PACE 2016-2020

LAND ROVER: DISCOVERY 2017-2018, DISCOVERY 3 2004-2009, DISCOVERY 4 2009-2017, RANGE ROVER 2012-2020, RANGE ROVER SPORT 2005-2020, RANGE ROVER VELAR 2017-2020

PEUGEOT: 407 2004-2009, 407 COUPE 2006-2012, 607 2004-2011

## UTENSILI OEM

0188K	303 1116
0195C	303 11117
0195H	303 1126
0195K	303 1132

## CODICE MOTORE

AJ-V6D/306DT	X8Z
DT17BTED4(UHZ)	276DT
DT20C(X8C)	276DT (7B/7G)
DT20C(X8Z)	306DT
D20CTED4(X8Z)	7B
UHZ	7G
X8C	

## 54680



STRUMENTO PER LA FASATURA  
CITROËN/PEUGEOT PURETECH

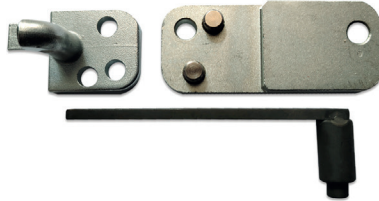

## MODELLO

CITROËN: BERLINGO IV (18-20), C1 II (14-18), C3 III (12-17), C3 IV (16-18), C4 CACTUS (14-20), C4 AIRCROSS (18-20), C-ELYSEE (12-18), DS3 (12-18).

PEUGEOT: 108 (14-18), 208 (12-21), 2008 (13-21), 301 (13-21), 308 (13-21), 3008 (16-21), 508 (19-21), 5008 (14-21), PARTNER III (15-18), PARTEN IV (18-21), RIFTER (19-21)

## UTENSILI OEM

EN-52127-2	0109-6
01092B	0197-N
0109-2C	
0109-2D	

## CODICE MOTORE

D12XHL	EB2ADTS/LEG
D12XHT	EB2ADTS/LES
EB2ADT	EB2ADTS/LES/D12XHT
EB2ADTD	EB2ADTX
EB2ADTH	EB2ADTX(HNN)
EB2ADT	EB2DT(HNZ)
EB2ADT/LES	EB2DTS (HNY)
EB2ADT/LES/D12XHL	F12XHT

## 54213



KIT DI ATTREZZI DI  
CRONOMETRAGGIO DEL MOTORE  
PER ROVER/PEUGEOT/FORD/  
VOLVO 2.0, 2.2L D

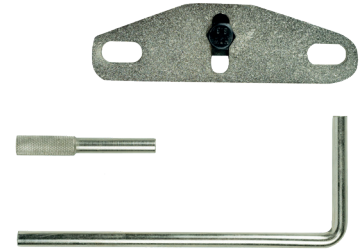

## MODELLO

CITROËN C4 (04-10), C5 II (04-10)

FORD S MAX 2.2 (08-10), GALAXY 2.2 (08-10), MONDEO 2.2, 2.0 (07-10)

LAND ROVER FREELANDER (06-10)

PEUGEOT 807 (05-11), 407 (05-11), 607 (05-09)

VOLVO S40 (03-10), V50 (06-10), C70 (06-10), C30 (06-10), V70 (07-10)

## UTENSILI OEM

0188.F	303-1277	999-7121
0188.M	303-393A	999-7122
0188.X	303-393-01	
303-1059	303-735	
303-1270	999-7119	
303-1272	999-7120	

## CODICE MOTORE

AZBA	QXBB	4HR
AZBC	QXWA	4HS
AZWA	QXWB	4HT
DW10BTED4	Q4BA	
DW10UTED4	RHK	
DW12BTED4	RHR	
D420T	224DT	
QXBA	4HP	

## 54467



KIT FASATURA BENZINA-VOLVO 1.5/2.0



## MODELLO

S60  
V40  
V40 CROSSCOUNTRY  
V60  
V60 CROSSCOUNTRY  
V70  
XC60  
XC70

## UTENSILI OEM

19997495  
9997490  
9997493  
9997496  
9997497

## CODICE MOTORE

VOLVO B4204 engine (8-Speed Transmission)

## 54462



ALLINEATORE DELL'ALBERO DI BILANCIAMENTO - FORD 2.2 DIESEL



### MODELLO

CITROËN C5, C5 II, C5 III, C6, C8, C-CROSSE HDI (200-2015) ENGINE CODES: 4HX (DW12CTED4), 4HP (DW12BTED4), 4HX (DW12TED4), 4HW (DW12TED4/L4)

FORD GALAXY, MONDEO, S-MAX, TDCI, TCI (2008-2015) ENGINE CODES: KNBB, KNBA, KNWA, Q4BA

LAND ROVER DISCOVERY, DISCOVERY SPORT, FREELANDER 2, ED4, TD4, TD4E (2009-2015) ENGINE CODES: 224DT, DW12CTED4/224DT, DW12BTED4/224DT

MITSUBISHI OUTLANDER DI-D, DI-DC (2007-2013) ENGINE CODES: 4HK, 4HN

PEUGEOT 4007, 407, 607, 807, 406, 508, 607, HDI, GT HDI (2000-2015) ENGINE CODES: DW12MTED4 (4HK), DW12MTED4 (4HN), DW12BTED4 (4HP), DW12BTED4 (4HR), DW12BTED4 (4HT), DW12TED4/L4 (4HW), DW12BTED4 (4HS), DW12ATED (4HZ), DW12ATED4 (4HX), DW12ATED (4HZ), DW1

### UTENSILI OEM

303-1328

303-1329

303-1330

### CODICE MOTORE

DW12ATED (4HZ)

DW12ATED4 (4HX)

DW12BTED4 (4HP)

DW12BTED4 (4HR)

DW12BTED4 (4HS)

DW12BTED4 (4HT)

DW12BTED4/224DT

DW12CTED4 (4HL)

DW12CTED4/224DT

DW12MTED4 (4HK)

DW12MTED4 (4HN)

DW12TED4/L4 (4HW)

KNBA

KNBB

KNWA

Q4BA

224DT

4HK

4HN

4HP (DW12BTED4)

4HW (DW12TED4/L4)

4HX (DW12CTED4)

4HX (DW12TED4)

## 53318



ESTRATTORE RUOTA DENTATA DI ALBERO A CAMME PER FORD / PSA



### MODELLO

CITROËN: C3 III (1015), DS3 (1015), XSARA II (0015), XSARA PICASSO (9910), C4 (0411), C4 II (1115), C4 PICASSO / GRAND PICASSO (1015), C4 AIR CROSS (1215), C5 (0005), C5 II (0408), C5 III (1015), DS4 (1115), XANTIA (9801), SYNERGIE/EVASION (9903), C8 (0215)

FORD: 1.4TDCI, 1.6TDCI, 1.8DI/TDDI/TDCI, 2.0TDCI (BELT), FIESTA, COURIER, FUSION, FOCUS/C-MAX, MONDEO, S-MAX, GALAXY, TOURNEO, CONNECT, TRANSIT CONNECT.

MAZDA 2, 3

PEUGEOT: 107 (0510), 1007 (0510), 206 (0109), 206CC (0507), 208 (1214), 306 (9902), 307 (0106), 307CC (0509), 308 (1114), 308CC (0914), 407 (0811), 407 COUPE (0712), 508 (1114), RCZ (1014), 2008 (1314), 3008 (1014), 4008 (1214), 5008 (1014), BIPPER (0810)

### UTENSILI OEM

21-229

303-651

### CODICE MOTORE

AZBA KLBA

AZBC LPBA

AZWA QXBA

AZWC QXBB

BHDA RTN

BHDB RTP

BHPA RTQ

C9DA TXBA

C9DB TXDA

C9DC TXDB

DC4TED TXWA

DV4C TYBA

DV4DT TYDA

F6JA TYWA

F6JB UFBA

F6JC UFDB

G6DA UFWA

G6DB UKBA

G6DC UKBB

G6DD UKDB

G6DE UKWA

G6DF 8HP

G6DG 8HS

HHJD 8HX

KHBA 8HZ

## 54466



KIT FASATURA DIESEL-VOLVO 2.0D

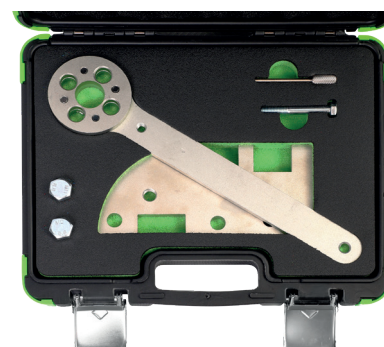

### MODELLO

S60

S80

S90

V40

V60

V70

V90

XC40

XC60

XC70

XC90

### UTENSILI OEM

999 7233

999 7495

### CODICE MOTORE

D4204T11

D4204T12

D4204T13

D4204T14

D4204T16

D4204T20

D4204T23

D4204T4

D4204T5

D4204T6

D4204T7

D4204T8

D4204T9

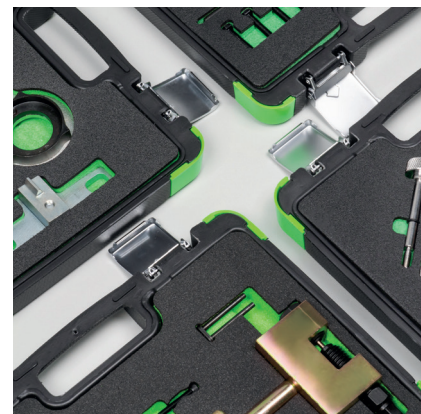

### 53293

4.15 - 2 48

#### KIT DI ATTREZZI DI REGOLAZIONE CINGHIA DENTATA PER- FORD



#### MODELLO

DIESEL 1.4, 1.6, 1.8, 2.0  
 PETROL 1.25, 1.4, 1.6, 1.6 VCT-TI, 1.7, 1.8, 2.0

#### UTENSILI OEM

3031054  
 3031059  
 3031097  
 303193 21104  
 303376 21162B  
 30339301  
 303651 21229  
 303734 21262  
 303748

#### CODICE MOTORE

ALDA	GZFB	RFN
AOBA	GZFC	RHBA
AOBC	G6DA	RKA
AODA	G6DB	RKB
AODB	G6DC	RKC
AODE	G6DD	RKF
AOWA	G6DE	RKH
AOWB	G6DF	RKJ
ASDA	G6DG	RKK
ASDB	G8DA	RTJA
AZBA	G8DB	RTJB
AZBC	G8DD	RTN
AZWA	HCPA	RTP
AZWC	HCPB	RTQ
BHDA	HHDA	RWPA
BHDB	HHDB	RWPC
BHPA	HHJA	R2PA
CDDB	HHJB	R3PA
CGBA	HHJC	SEBA
CGBB	HHJD	SEWA
CHBA	HHJE	SIDA
CHBB	HHJF	SNJA
CJBA	HMDA	SNJB
CJBB	HXDA	SNJC
CSDA	HXDB	SNJD
CSDB	HXJA	SPJA
C9DA	HXJB	SPJC
C9DB	IQDA	SPJD
C9DC	IQDB	SPJE
DHA	IQDC	STJA
DHB	IQDE	STJB
DHC	IQJA	STJC
DHD	IQJC	STJD
DHE	IQJE	SYDA

DHF	IXDA	TBBA
DHG	JQDA	TBBB
EDBA	JQDB	TBWA
EDBB	JQMA	TBWB
EDBC	JTBA	TXBA
EDBD	JTDA	TXDA
EDDB	JTDB	TXDB
EDDC	JTWA	TXMA
EDDD	JTWB	TXWA
EDDF	KHBA	TYBA
EYDB	KKDA	TYDA
EYDC	KKDB	TYWA
EYDD	KLBA	TZJA
EYDE	KLWA	TZJB
EYDF	KNBA	T7DB
EYDG	KVJA	T8DA
EYDI	LPBA	UFBA
EYDJ	MUDA	UFDA
EYDL	MUDD	UFDB
EYPA	M7JA	UFMA
EYPC	M7JB	UFWA
FFBA	M8DA	UKBA
FFDA	M8DB	UKBB
FFWA	M8MD	UKDA
FHA	M9DA	UKDB
FHB	M9DB	UKMA
FHD	NGA	UKWA
FHE	NGB	UTJA
FHF	NGC	XTDB
FUJA	NGD	YF
FUJB	N4JB	
FXDA	PNBA	
FXDB	PNDA	
FXDC	PNDD	
FXDD	P7PA	
FXJA	P9PA	
FXJB	P9PB	
FXJC	QQDA	
F6JA	QQDB	
F6JB	QQDC	
F6JC	QQDD	
F6JD	QXBA	
F8JA	QXBB	
F8JB	QXWA	
F9DA	QXWB	
F9DB	QYBA	
GPDA	QYWA	
GZ	Q4BA	
GZFA	Q7DA	

### 53294

3.70 - 2 40

#### KIT DI ATTREZZI DI REGOLAZIONE CINGHIA DENTATA PER FORD MAZDA

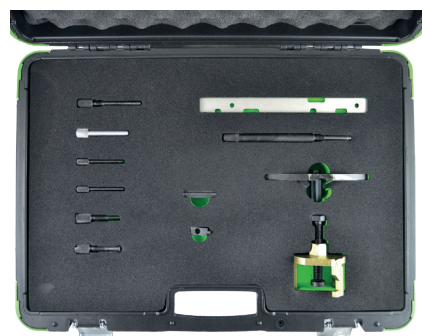

#### MODELLO

CITROËN C1 (05-10), C2 (03-10), C3 I/II (02-10), C3 III (10-15), C3 PLURIEL (04-10), C3 PICASSO (09-12), C4 (04-11), C4 II(11-15), C4 PICASSO (06-12), C4 GRAND PICASSO (10-12), DS3 (09-12), DS4 (11-12), DS5 (12-15), C5 II (04-08), C5 III (04-12), XSARA II  
 FORD COURIER (00-02), C-MAX (03-10), FIESTA (02-11), FOCUS (98-11), FUSION (02-11), GALAXY (06-10), KUGA (06-10), MONDEO (07-10), S-MAX (06-10), TOURNEO CONNECT (02-13), TRANSIT CONNECT (02-13)  
 MAZDA 2 (02-15), 3 (09-14)  
 PEUGEOT BIPPER (08-10) DISPATCH/JUMPY III (07-12) EXPERT III (07-12) NEMO (08-10) PARTNER I/II (05-11) PARTNER III (08-16) 107 (05-10) 1007 (05-10) 206 (01-12) 206+ (09-13) 206 CC (05-07) 207 (06-13) 207 CC (07-15) 208 (11-15) 307 (01-08) 308 (07-15) 308

#### UTENSILI OEM

0194-A 303-393  
 0194B 303-393/01  
 0194-C 303-651  
 303-1059 303-732  
 303-193 303-734  
 303-376B 303-735

#### CODICE MOTORE

AZWA	DV6C (9HD)	G6DA
BHPA	DV6C (9HL)	G6DB
C9DA/B	DV6C (9HR)	G6DC
C9DC	DV6CATED (9HX)	G8DA
DVTEd4 (8HV)	DV6CTED (9HC)	G8DB
DVTEd4 (9HV)	DV6D (9HP)	HCBP
DV4C (8HP)	DV6DTED (9HF)	HCPA
DV4C (8HR)	DV6DTED (9HJ)	HHDA
DV4TD (8HT)	DV6DTED (9HP)	HHDB
DV4TD (8HW)	DV6TED (9HN)	HHJA
DV4TD (8HX)	DV6TED (9HD)	HHJB
DV4TD (8HZ)	DV6TED (9HP)	KKDA
DV4TED (8HS)	DV6TED4 (9HV)	MZ-CD
DV4TED4 (8HX)	DV6TED4 (9HW)	P7PA
DV4TED4 (8HY)	DV6TED4 (9HX)	P9PA
DV6 (9HR)	DV6TED4 (9HY)	QXWA
DV6AT (9HX)	DV6TED4 (9HZ)	QXWB
DV6ATED (9HX)	DV6TED4B	RHE
DV6ATED (9HY)	DV6TED4B (9HV)	RTN
DV6ATED4 (9HX)	DV6TED4BU (9HS)	RTQ
DV6AUTED4 (9HX)	DV6UTED4 (9HU)	RWPA
DV6BTED4 (9HT)	DV6UTED4 (9HX)	R2PA
DV6BTED4 (9HW)	FFBA	R3PA
DV6BUTED4 (9HT)	F6JA	Y6
DV6C (BHX)	F6JB	
DV6C (BHZ)	F6JC	

## 54594

1.80 - 5 180

KIT DI TEMPORIZZAZIONE BENZINA  
1.5 ECOBOOST FORD



### MODELLO

FIESTA DURATEC 2018  
FOCUS ECOBOOST 2018  
FOCUS ST ECOBOOST 2018  
KUGA 1.5L ECOBOOST (I3) 2019

### UTENSILI OEM

303-1643  
303-1645  
303-1649

### CODICE MOTORE

YZDA  
YZJA  
Y1DA  
Y2DA

## 54592

1.75 - 5 120

KIT DI TEMPORIZZAZIONE BENZINA  
FORD ECOBOOST



### MODELLO

FORD (FOX ENGINE) MODELS: C-MAX (FROM 2017)  
FIESTA (FROM 2017), FOCUS (FROM 2018), PUMA (FROM  
2019), TRANSIT CONNECT (FROM 2017)

### UTENSILI OEM

0132AB  
1.860.617.000  
2 450 487  
23-019  
303-160  
303-1603  
303-1643  
303-1661  
4527-TS2  
999-7169

### CODICE MOTORE

1.0 EcoBoost: B3DA, B7DA, B7JA, MOJA, MOJB  
1.0 EcoBoost Hybrid: B7JB, BZJA, B7DC, M0DC  
1.0 SCTI EcoBoost: B3GA, B3GB

## 53295

2.10 - 5 165

KIT DI ATTREZZI DI REGOLAZIONE  
CINGHIA DENTATA PER FORD  
1,8TDDI, TDCI



### MODELLO

C-MAX (07-10), COURIER (00-02), FIESTA (00-02), FO-  
CUS (98-11), FOCUS C-MAX (03-07), GALAXY (06-10),  
MONDEO (07-10), S-MAX (06-14), TOURNEO CONNECT  
(02-13), TRANSIT CONNECT (02-13)

### UTENSILI OEM

303193(21104)  
303376(21162)  
303393(21168)  
303652(21230)  
310095(23067)

### CODICE MOTORE

BHDA	KKDA
BHDB	KKDB
BHPA	P7PA
C9DA	P9PA
C9DB	P9PB
C9DC	QYBA
FFBA	QYWA
FFDA	RTN
FFWA	RTP
F9DA	RTQ
F9DB	RWPA
HCPA	RWPC
HCPB	R2PA
KHBA	R3PA

## 54421

1.45 - 5 135

INSTALLATORE CINGHIA AUSILIARIA FORD/VOLVO 1.4 1.6



### MODELLO

FORD: FOCUS, C-MAX, MONDEO  
VOLVO: S40, C30, V50

### UTENSILI OEM

303-1179

### CODICE MOTORE

B4164S3	C16HHDEY
CH16HDEZ	FUJA
C12HM7AD	FXJA
C12LM7AA	FYJA
C14HDEZ	ZH12FUJA
C14HHCDB	ZH12FUJB

ZH12M7JB	ZH16FYDC
ZH14ASDA	ZH16FYDD
ZH14FXDA	ZH16FYJA
ZH14FXDB	ZH16HWDA
ZH14FXDC	ZH16HXDA
ZH14FXDD	ZJ16FYJB
ZH14FXJA	16HDEZ
ZH14FXJB	
ZH16FYDA	
ZH16FYDB	

## 53296

 2.30  -  5  120

KIT DI ATTREZZI PER MONTAGGIO E REGOLAZIONE POMPA CARBURANTE PER FORD/JAGUAR DURATORQ



## MODELLO

1.4 TDCI 1.4HDI 8V, 1.4 HDI 16V, 1.5 TDCI / ECONETIC, 1.5 BLUEHDI, 1.5 ECOBLUE TDCI, 1.6 HDI 16V, 1.6 HDI 8V TURBO, 1.6 BLUE HDI

## UTENSILI OEM

EN-52138	21 263
KM-6349	21-260
0132AB	303 675
0132AJ1	303 734
0178D	303 735
0187B	3031277
0189B	303-732
0194A	4527 TS2
0194B	49 JE02 018
0194C	49 JE02 020
077440010400	49 JE02 021
09919 58120	5711 TD
11 9 790	99360608
1.860.617.000	999 7121
21 234	999 7169
21 262	

## CODICE MOTORE

ABFA	N7BA
BG	N7BB
CYFA	PGFA
CYFB	PGFB
CYFC	PHFA
DOFA	PHFC
DRFA	P22DTE (4HM)
DRFB	P22DTE (4HU)
DRFC	P22DTE (4HV)
D2FA	P8FA
D2FB	P8FB
D3FA	QJBA
D4FA	QJBA (BG)
D5BA	QJBB
D6BA	QJBC
FIFA	QJBD
FMBA	QVFA
FMBB	QWFA
FXFA	SRFA
F3FA	SRFB
F4FA	SRFC
HJBA	SRFD
HJBB	SRFE
HJBC	Td4244DT
HJBE	UHFA
H9FA	4HM
H9FB	4HU
H9FD	4HV
JXFA	424.2
JXFC	

## 54424

 3.85  -  2  48

KIT DI MESSA IN FASE PER FORD 2.0 ECOBOOST

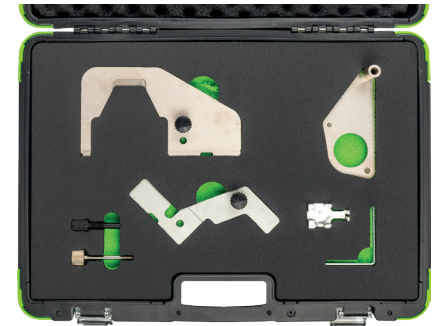

## MODELLO

FORD: FOCUS 2011-2018, GALAXY 2010-2018, MONDEO 2010-2018, S-MAX 2010-2018

## UTENSILI OEM

2MM TENSIONER	303-1595
303-1504	303-1600
303-1521	303-748
303-1565	

## CODICE MOTORE

MGDA	TNBB
R9CB	TNCC
R9CD	TNCD
R9CF	TNCF
R9CH	TNWA
R9DA	TNWB
R9DB	TPBA
R9DC	TPWA
R9DD	TVDA
TNBA	XQDA

## 54420

 4.82  -  2  135

SET REGOLAZIONE CARBURANTE - FORD / VOLVO 2.5 (EURO 4)



## MODELLO

FORD: FOCUS 2.5 RS / ST, MONDEO 2.5, S-MAX 2.5, GALAXY 2.5 ST (2005-)  
VOLVO: C30 (06-10), C70 (98-10), S40 (96-10), S60 (00-09), S70 (97-07), S80 (98-06), V40 (96-10), V50 (04-10), V70 (97-07), XC70 (02-07), XC90 (02-10)

## UTENSILI OEM

303-1178
303-1179
303-1182
303-1183
999 5433
999 5451
999 5452

## CODICE MOTORE

B4164S	B4204T5	B5244S5	B5254T6
B4164S2	B5234FS	B5244S7	B5254T7
B4184S	B5234T3	B5244T	B5254T8
B4184S10	B5234T4	B5244T2	HUBA
B4184S2	B5234T5	B5244T3	HUWA
B4184S3	B5234T6	B5244T4	HYBA
B4184S9	B5234T7	B5244T5	HYDA
B4194T	B5234T8	B5244T7	HYDC
B4194T2	B5234T9	B5254T10	JZDA
B4204S	B5244FS	B5254T11	
B4204S2	B5244SG	B5254T2	
B4204T	B5244SG2	B5254T3	
B4204T2	B5244S2	B5254T4	
B4204T3	B5244S4	B5254T5	



## 53653

5.50 - 2 48

ATTREZZO DI REGOLAZIONE CINGHIA DENTATA PER FORD

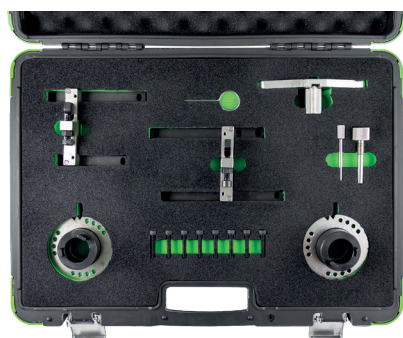

### MODELLO

FORD: B-MAX 2012-2018, C-MAX/GRAND C-MAX 2012-2020, ECOSPORT 2013-ON, FIESTA/ FIESTA ACTIVE 2013-ON, FOCUS/FOCUS ACTIVE 2012-ON, MONDEO 2015-2018, TOURNEO CONNECT 2014-ON, GRAND TOURNEO CONNECT 2013-2018, TRANSIT CONNECT 2014-ON, TRANSIT COURIER 2014-2019

### UTENSILI OEM

303-1054  
303-1602  
303-1604  
303-1605  
303-1606  
303-732  
503-393A

### CODICE MOTORE

M1CA	SFJA
M1CB	SFJB
M1DA	SFJC
M1DC	SFJD
M1DD	SFJE
M1DH	SFJH
M1JA	SFJJ
M1JC	SFJK
M1JE	SFJL
M1JH	SFJN
M1JJ	SFJP
M1JL	XMJA
M1JM	XMJB
M1JP	XMJC
M1JU	XMJD
M2DA	XPJA
M2DB	XPJB
M2DC	XPJC
M2GA	XPJD
M2GB	XYJA
P4JA	XYJB
P4JB	XYJC
P4JC	XYJD
P4JD	XYJE
QOJA	YYJA
QOJC	YYJB
SFCA	YYJC
SFCB	YYJD
SFCC	YYJE
SFCD	YYJF
SFDA	YYJG
SFDB	

## 53324

0.30 10 50 -

ATTREZZO DI REGOLAZIONE CINGHIA DENTATA PER FORD / MAZDA / VOLVO

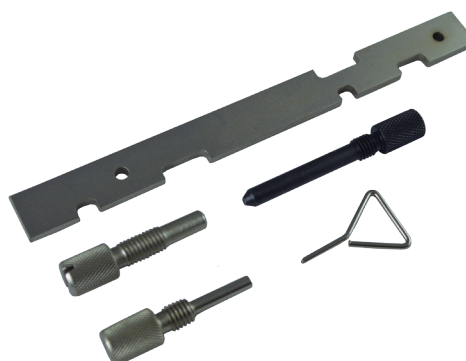

### MODELLO

FORD: COUGAR 1998-2001, FIESTA 1995-2017, FOCUS 1998-2014, FUSION 2002-2012, GALAXY 2006-2015, C-MAX 2003-2010, B-MAX 2012-2018, S-MAX 2006-2015, MONDEO 1998-2015, TOURNEO CONNECT 2002-2006, TRANSIT CONNECT 2002-2006, TRANSIT 2006-2011

MAZDA: 121 1995-2000, 2 2002-2007, 3 2003-2014, 5 2005-2015, 6 2002-2013, MPV 2002-2005, MX-5 2005-2015, TRIBUTE 2004-2006

VOLVO: C30 2006-2013, S40 2004-2012, S80 2007-2011, V50 2004-2012, V70 2007-2011

### UTENSILI OEM

EN-51418	303-1054
JE01054	3031097
JE01061	303376
JE02061	303376B
JLR30374	303507
MB995208	303748
T03006	49JE01054
T10115	49JE01061
T4031	9997151
0198-J	9997152
114120	9997406
21210	9997429
21259	

### CODICE MOTORE

ALDA	EDBD
AOBA	EDDB
AOBC	EDDC
AODA	EDDD
AODB	EDDF
AODE	EYDB
AOWA	EYDC
AOWB	EYDD
ASDA	EYDE
ASDB	EYDF
B4164 S3	EYDG
B4184 S11	EYDI
B4184 S8	EYDJ
B4204 S3	EYDL
B4204 S4	EYPA
CDBB	EYPC
CFBA	FHA
CGBA	FHD
CGBB	FHE
CHBA	FHF
CHBB	FUJA
CJBA	FUJB
CJBB	FXDA

CSDA	FXDB
CSDB	FXDC
DHA	FXDD
DHB	FXJA
DHC	FXJB
DHD	FXJC
DHE	FYDA
DHF	FYDB
DHG	FYDC
EDBA	FYDD
EDBB	FYDH
EDBC	FYJA
FYJB	RKB
FXJC	RKF
F8JA	RKH
F8JB	RKJ
GZFA	RKK
GZFB	RTJA
GZFC	RTJB
HMDA	RTJC
HWDA	RTJD
HWDB	RTJE
LF	SEBA
LIF	SEWA
L1J	SHDA
L1L	SHDB
L1N	SHDC
L1Q	SNJA
L1T	SNJB
L1V	SNJC
L1W	SNJD
L3	SPJA
L8	SPJC
M7JA	SPJD
M7JB	SPJE
NGA	STJA
NGB	STJB
NGC	STJC
NGD	STJD
N4JB	SYDA
QQDA	TBBA
QQDB	TBBB
QQDC	TBWA
QQDD	TBWB
QQDE	UTJA
Q7DA	
RKA	

### 54201

1.05 5 10 240

SET DI STRUMENTI PER LA FASATURA DEL MOTORE FORD



**MODELLO**

C-MAX(07 - 10), C-MAX/GRAND C-MAX(10-18), FIESTA(08-18), FOCUS/ FOCUS C-MAX(04-11), FOCUS(11-18), MONDEO(07-15)

**UTENSILI OEM**

MOT 1430	303-1059
0132AJ1	303-1097
0187B	303-1270
0188M	303-1277
0188X	303-735
0189B	303-748
0194B	999 7122
21-259	999-7121
21-263	999-7152
303-1054	

**CODICE MOTORE**

G6DA
G6DB
G6DC
HXDA
YSKD

### 54204

2.55 - 5 150

KIT DI ATTREZZI DI CRONOMETRAGGIO DEL MOTORE PER FORD 2.0 ECOBLUE

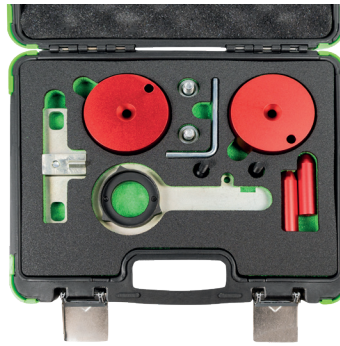

**MODELLO**

EDGE (2018-21)  
 FOCUS ACTIVE (2019-ON)  
 FOCUS (2018 - ON)  
 GALAXY (2018-21)  
 KUGA (2019 - ON)  
 MONDEO (2019-21)  
 RANGER (2019-ON)  
 S-MAX (2018-21)  
 TOURNEO CUSTOM (2016 - ON)  
 TRANSIT CUSTOM (2016-ON)  
 TRANSIT (2016-ON)

**UTENSILI OEM**

303-1637
303-1643
303-1650

**CODICE MOTORE**

BCCC	YLR6	YNCA
YLCB	YMCB	YNFA
YLDA	YMFA	YNFB
YLFA	YMFB	YNFS
YLFB	YMF5	YNF6
YLFS	YMF6	YNRA
YLF6	YMHA	YNR6
YLRA	YMRA	

### 54208

1.95 - 5 135

KIT DI ATTREZZI DI CRONOMETRAGGIO DEL MOTORE PER FORD 2.0 ECO BOOST SCTI, TI-VCT



**MODELLO**

2.0 ECO BOOST FOCUS, GALAXY, MONDEO, S-MAX

**UTENSILI OEM**

3031504
3031521
3031565
303748

**CODICE MOTORE**

MGDA	TNBB
R9CB	TNCC
R9CD	TNCD
R9CF	TNCF
R9CI	TNWA
R9DA	TNWB
R9DB	TPBA
R9DC	TPWA
R9DD	XQDA
TNBA	YVDA

### 54209

0.85 5 10 240

KIT DI ATTREZZI DI CRONOMETRAGGIO DEL MOTORE PER FORD/MAZDA 2.2, 3.2 TDCI



**MODELLO**

FORD TRANSIT , RANGER, EVEREST  
 MAZDA BT-50

**UTENSILI OEM**

3031587
303675 /21-234
303698 /21-251

**CODICE MOTORE**

ABFA	CYFA	CYRA	DRFC
BG	CYFB	CYRB	DRFF
CVFF	CYFC	CYR5	DRFG
CVF5	CYFG	DOFA	DRF5
CVRB	CYFG	DRFA	DRRA
CVR5	CYF5	DRFB	DRRB

DRR5	GBVAJQW	PHFA	SA2S	4HG
D2FA	HJBA	PHFC	SA2W	4HH
D2FB	HJBB	P22DTE	SRFA	4HJ
D3FA	HJBE	P8FA	SRFB	4HM
D4FA	H9FA	P8FB	SRFC	4HU
D5BA	H9FB	QJBA	SRFD	4HV
D6BA	H9FD	QJBA BG	SRFE	4H03
FIFA	ID4/DT224	QJBB	UHFA	6B
FMBA	JXFA	QJBC	UHFB	
FMBB	JXFC	QJBD	UHR5	
FXFA	MZ-CD	QVFA	USRA	
F3FA	N7BA	QWFA	USRB	
F4FA	N7BB	QW2R	USR6	
GBVAJ	PD2 4P	SAFA	UYR6	
GBVAJPF	PGFA	SAFB	ZSD 424	
GBVAJQJ	PGFB	SA2R	244DT	

## 54223

2.40 - 5 135

KIT DI ATTREZZI DI BLOCCAGGIO DELLA RUOTA DENTATA DELL'ALBERO A CAMME PER FORD 1.5T



### MODELLO

FORD 1.5L DURATEC, ECOSPORT, FIESTA, FOCUS

### UTENSILI OEM

303-1639

303-1643

303-1647

303-1648

### CODICE MOTORE

Duratec

Sigma

UEJB

## 54224

1.75 - 5 135

KIT DI ATTREZZI PER INSTALLAZIONE E RIMOZIONE DELLA POMPA DI INIEZIONE PER FORD 2.0



### MODELLO

TRANSIT (17-18), TOURNEO CUSTOM (16-18), TRANSIT CUSTOM (16-18) 2.0 ECOBLUE TDCI

### UTENSILI OEM

303--1635/1

303-1635/3

303-1635/2

303-1635/6

### CODICE MOTORE

BCCA BLFC YMDA

BCCB BLFD YMFA

BCCC BLHA YMFB

BCFB BLRA YMFS

BCRA BLRB YMF6

BC2X YLCA YMHA

BJFA YLCB YMRA

BJFB YLCC YMR6

BJFC YLDA YNCA

BJFD YLDC YNFA

BJRA YLFA YNFB

BJRB YLFB YNFS

BKFA YLFS YNF6

BKFB YLF6 YNRA

BKFC YLRA YNR6

BKFD YLR6 YN2X

BKRA YL2X

BKRB YMCA

BLFA YMCA

BLFA YMCA

BLFA YMCA

BLFA YMCA

BLFA YMCA

BLFA YMCA

BLFA YMCA

BLFA YMCA

BLFA YMCA

BLFA YMCA

BLFA YMCA

BLFA YMCA

BLFA YMCA

BLFA YMCA

BLFA YMCA

BLFA YMCA

BLFA YMCA

BLFA YMCA

BLFA YMCA

BLFA YMCA

BLFA YMCA

BLFA YMCA

BLFA YMCA

BLFA YMCA

BLFA YMCA

BLFA YMCA

BLFA YMCA

BLFA YMCA

## 54260

7.50 - 2 80

KIT DI MOLTIPLICATORE DI FORZA 5:1 PER MOTORI FORD ECOBOOST



### MODELLO

FORD B-MAX (2012-2018)

FORD C-MAX (2012-2018)

FORD ECOSPORT (2015-2019)

FORD FIESTA (2012-2019)

FORD FOCUS (2012-2018)

FORD GRAND C-MAX (2017-2018)

FORD GRAND TOURNEO CONNECT (2013-2018)

FORD MONDEO (2015-2018)

FORD TOURNEO COURIER (2014-2020)

FORD TRANSIT CONNECT (2013-2018)

FORD TRANSIT COURIER (2014-2020)

### UTENSILI OEM

303-1611

303-1611-02

303-1611-01

### CODICE MOTORE

B3DA

M2DB

SFDB

B7DA

M2DC

SFJA

M1CA

M2GA

SFJB

M1CB

M2GB

SFJC

M1DA

P4JA

SFJD

M1DD

P4JB

XMJA

M1JA

P4JC

XMJB

M1JC

P4JD

XMJC

M1JE

SFCA

XMJD

M1JH

SFCB

YYJA

M1JJ

SFCC

YYJB

M2DA

SFCD

## 54463

6.00 - 5 48

KIT FASATURA DIESEL-JAGUAR/LAND ROVER 2.0D



### MODELLO

JAGUAR E PACE

JAGUAR F PACE

JAGUAR XE

JAGUAR XF

LAND ROVER DEFENDER

LAND ROVER DISCOVERY

LAND ROVER DISCOVERY SPORT

LAND ROVER RANGE ROVER EVOQUE

RANGE ROVER SPORT

RANGE ROVER VELAR

### UTENSILI OEM

JLR-303-1625

JLR-303-1627

JLR-303-1630

### CODICE MOTORE

AJ20 - 204DT

AJ20 - 204DTA

AJ200 - 204DTA

AJ200 - 204DTD

AJ200D

AJ200D - 204DT

AJ200D - 204DTA

204DTA

204DTD

## 54464

6.00 - 5 48

KIT FASATURA BENZINA-JAGUAR/  
LAND ROVER



### MODELLO

JAGUAR E-PACE
JAGUAR F-PACE
JAGUAR F-TYPE
JAGUAR XE
JAGUAR XF
JAGUAR XJ
LAND ROVER DEFENDER
LAND ROVER DISCOVERY
LAND ROVER DISCOVERY SPORT
LAND ROVER RANGE ROVER
LAND ROVER RANGE ROVER EVOQUE
LAND ROVER RANGE ROVER SPORT
LAND ROVER RANGE ROVER VELAR

### UTENSILI OEM

JLR-303-1625
JLR-303-1627
JLR-303-1630

### CODICE MOTORE

AJ20 - PT204
AJ200 - PT204
AJ200P
PT204

## 54465

1.20 - 2 48

KIT DI MESSA IN FASE PER JAGUAR/  
LAND ROVER-3.0/5.0

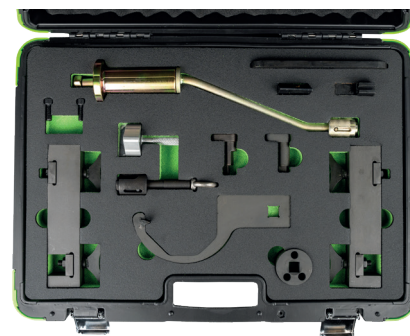

### MODELLO

JAGUAR AJ133
JAGUAR F-TYPE
JAGUAR XF/XFR (X250)
JAGUAR XJ/XJR (X351)
JAGUAR XK/XKR (X150)
JAGUAR X150 - XK (10MY)
JAGUAR X250 - XF (10MY)
JAGUAR X351 - XJ (10MY)
LAND ROVER DISCOVERY 4 (2009-2013)
LAND ROVER RANGE ROVER SPORT (2009-)
LAND ROVER RANGE ROVER (2009-2017)

### UTENSILI OEM

1303-1445
303-1447
303-1448
303-1452
303-1482

### CODICE MOTORE

AJ133
XF/XFR (X250)
XJ/XJR (X351)
XK/XKR (X150)
X150-XK
X250-XF
X351-XJ

## 53297

1.20 - 10 -

KIT DI ATTREZZI DI REGOLAZIONE  
CINGHIA DENTATA PER JAGUAR/  
LAND ROVER



### MODELLO

JAGUAR S-TYPE, XF, S.J6, XJ, F-PACE (2.7 - 3.0)
LAND ROVER DISCOVERY 3, DISCOVERY 4, DISCOVERY, RANGE ROVER, RANGE ROVER SPORT, RANGE ROVER VELAR (2.7 - 3.0)

### UTENSILI OEM

0195H
303 1116
303 1117
303 1126
303 1132

### CODICE MOTORE

AJ-V6D
276DT
306DT
7B
7G

## 53298

2.60 - 5 160

KIT DI ATTREZZI DI REGOLAZIONE CINGHIA DENTATA PER LAND ROVER



### MODELLO

LAND ROVER DEFENDER 1990 - 1999
LAND ROVER DISCOVERY 1990 - 1998
LAND ROVER FREELANDER 1997 - 2000
LAND ROVER RANGE ROVER 1993 - 1995
LAND ROVER 110 1985 - 1990
LAND ROVER 90 1985 - 1990

### UTENSILI OEM

LRT 12 058	12 058
LRT12060	12 060
LST 107	18G 1458
LST 129	18G 1523
LST 136	18G 1524
LST128	18G 1717A

303 825	303 877
303 863	303 896
303 864	303851
303 868	

### CODICE MOTORE

12J
19L
20T2N
20T4

## 54422

5.00 - 2 48

KIT REGOLAZIONE EQUILIBRIO ASSE  
JAGUAR/LAND ROVER 2.0D



### MODELLO

JAGUAR: E-PACE D150, D180, D240 (X540) (2017-),  
F-PACE 20D, 25D, E-PERFORMANCE (X761) (2016-), XE  
20D, 25D, E-PERFORMANCE (X760) (2015-), XF 20D,  
25D, E-PERFORMANCE (X260) (2015-)

LAND ROVER: DEFENDER SD4 D200, SD4 D240 (L663)  
(2019-2021), DISCOVERY SPORT ED4, SD4, TD4, D150,  
D180, D240 MHEV (L550) (2015-), DISCOVERY SD4, TD4  
(L462) (2017-2021)

RANGE ROVER: EVOQUE ED4, SD4, TD4 (L538) (2015-  
2019), EVOQUE D150, D180, D240 MHEV (L551) (2019-),  
SPORT SD4 (L494) (2016-2018), VELAR D180, D240  
(L560) (2017-)

### UTENSILI OEM

JLR-303-1662

JLR303-1663-1

JLR303-1663-2

JLR303-1663-3

JLR-303-1664

JLR-303-1665

### CODICE MOTORE

AJ200

AJ200D

204DT

204DTA

204DTD

## 54423

2.13 - 5 135

KIT DI MESSA IN FASE PER LAND  
ROVER 3.6D



### MODELLO

RANGE ROVER SPORT: 3.6 (TDV8) DIESEL (2006-2011)

RANGE ROVER: 3.6 (TDV8) DIESEL (2006-2011)

### UTENSILI OEM

303-1234

303-1236

303-1238

303-1239

303-1243

303-1620

### CODICE MOTORE

368DT

## 54425

4.85 - 2 44

KIT DI MESSA IN FASE PER LAND  
ROVER FREELANDER V6/ROVER KV6  
2.0L, 2.5L



### MODELLO

LAND ROVER: FREELANDER (2000-2006)

MG: ZR (2004-2005), ZS (2001-2005), ZT (2001-2005)

ROVER: 45 (1999-2005), 75 (1999-2005), 825 (1996-1999)

### UTENSILI OEM

LRT 12 175 12 198

LRT 12 187 12 232

LRT 12 195 18G 1746A

LRT 12 196 18G 1747

LRT 12 198 18G 1747 2

LRT 12 232 18G 1747 5

T40011 18G 17471

12 175 303 973

12 187 303 986

12 196 303 989

### CODICE MOTORE

KV6

## 54426

2.70 - 5 135

KIT DI MESSA IN FASE PER JAGUAR/LAND ROVER 3.2, 3.5, 4.0, 4.2, 4.4



### MODELLO

DAIMLER: V8 (97-03), SUPER V8 (97-03), SUPER EIGHT  
(05-10)

JAGUAR: S-TYPE (99-08), XF (08-09), XJR (97-10), XJ8  
(97-10), XKR (98-09), XK8 (96-09)

LAND ROVER: DISCOVERY III (04-09) RANGE ROVER  
(05-09), RANGE ROVER SPORT (05-09)

### UTENSILI OEM

T40011 303533

303530 303645

303531 303654

303532

### CODICE MOTORE

AC LB 1G

BC LC 2B

CC MA 3B

CE MB 428PS

DC NB 448PN

EC NC 5G

GB PB 9G

GC PC

HB RB

HG SB

KB TB

KC 1B

## 54427

5.55 - 2 48

ATTREZZO PER IL BLOCCAGGIO DELLA PULEGGIA DELL'ALBERO MOTORE JAGUAR/LAND ROVER 4.0, 4.2, 4.4



### MODELLO

DAIMLER: V8; 4.0 (97-98)

JAGUAR: S-TYPE; 3.2, 3.5, 4.2 V8 (99-08), XF; 3.2, 3.5, 4.2 V8 (08-09), XJ; 3.2, 3.5, 4.2 V8 (97-08), XJ8; 4.0 (97-98), XK; 3.2, 3.5, 4.2 V8 (97-08), XK8; 4.0 (97-98)

LAND ROVER: DISCOVERY3; 4.2, 4.4 LA V8 (05-09), RANGE ROVER; 4.2, 4.4 SPORT LS V8 (05-09), RANGE ROVER; 4.2, 4.4 LM V8 (06-08)

### UTENSILI OEM

LRT 12 080	303 191 03
18G 1437	303 191 04
18G 1437 2	303 588
303 191	303 893

### CODICE MOTORE

AJ26	42D
AJ27	428PS
AJ28	448PN
AJ34	56D
30G	58D
36D	94D

## 54428

1.03 5 10 240

KIT DI MESSA IN FASE PER CHRYSLER/JEEP 2.8 CRD



### MODELLO

CHRYSLER: GRAND VOYAGER 2.8 (2008-)

DODGE: NITRO 2.8 (2007-)

JEEP: CHEROKEE 2.8 (2008-), WRANGLER 2.8 (2007-)

### UTENSILI OEM

VM 9991  
VM 9992

### CODICE MOTORE

ENS (VM10D)  
ENS (VM11D)  
ENS (VM51C)  
ENS (VM52C)  
ENS (VM64C)  
VM10D  
VM11D  
VM51C  
VM52C  
VM64C

## 54429

1.90 5 135

KIT DI MESSA IN FASE PER CHRYSLER/JEEP 3.0D



### MODELLO

CHRYSLER 300 C (2012 - 2015)

JEEP GRAND CHEROKEE (2011 -)

### UTENSILI OEM

VM 10359  
VM10338 1  
VM10338 2  
VM10339  
VM10359  
VM10359A

### CODICE MOTORE

EXF  
EXF VM23D  
EXF VM44D  
EXF VM63D  
VM23D  
VM44D  
VM63D

## 54207

1.30 5 10 240

KIT DI ATTREZZI DI CRONOMETRAGGIO DEL MOTORE PER CHRYSLER/JEEP LDV 2.5 CRD



### MODELLO

CHRYSLER VOYAGER (01-08), GRAND VOYAGER (01-08)

JEEP CHEROKEE (01-08)

LDV MAXUS (05-09)

### UTENSILI OEM

VM1052  
VM1053  
VM1068  
VM1080  
VM1089  
VM8873  
VM9660

### CODICE MOTORE

R2516C  
R2516K  
R2516L  
R2516L VM39/40B  
R2816C5.05A  
R2816K4

## 53270

1.40 - 10

KIT DI ATTREZZI DI REGOLAZIONE CINGHIA DENTATA PER MERCEDES/CHRYSLER/JEEP

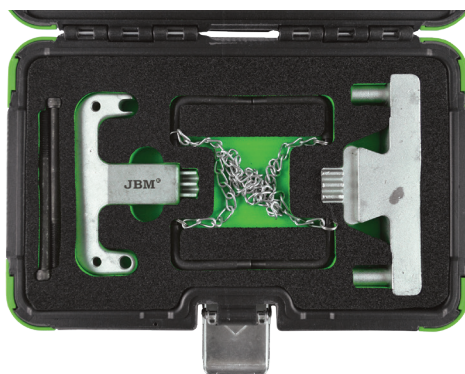

### MODELLO

CHRYSLER
JEEP
MERCEDES

### UTENSILI OEM

111589031500	8932
601589024000	8933
602589004000	
8929	

### CODICE MOTORE

M104.941	M111.947
M104.943	M111.948
M104.944	M111.950
M104.945	M111.951
M111.920	M111.952
M111.921	M111.955
M111.941	M111.956
M111.942	M111.957
M111.943	M111.958
M111.944	M111.961
M111.945	M111.970
M111.946	M111.973

M111.974	OM601.915
M111.975	OM601.942
M111.977	OM601.943
M111.978	OM601.970
M111.979	OM602.980
M111.980	OM602.982
M111.981	OM602.984
M111.982	OM602.985
M111.983	OM603.971
M111.984	OM604.910
M119970	OM604.912
M119971	OM604.917
M119972	OM605.910
M119980	OM605.912
M119981	OM605.960
M119982	OM605.962
M119985	OM606.912
M120.980	OM606.961
M120.981	OM606.962
M120.982	OM611.960
M120.983	OM611.961
M271.820	OM611.962
M271.860	OM611.980
OM601.913	OM611.981

OM611.987	OM646.966
OM612.961	OM646.980
OM612.962	OM646.981
OM612.963	OM646.982
OM612.967	OM646.983
OM612.981	OM646.984
OM613.960	OM646.986
OM613.961	OM646.989
OM628.960	OM646.990
OM628.961	OM647.961
OM628.962	OM648.960
OM628.963	OM648.961
OM629.910	
OM629.911	
OM629.912	
OM642.990	
OM646.811	
OM646.812	
OM646.820	
OM646.821	
OM646.951	
OM646.961	
OM646.962	
OM646.963	

## 53271

4.55 - 2 - 40

KIT DI ATTREZZI DI REGOLAZIONE CINGHIA DENTATA PER MERCEDES BENZ M271



### MODELLO

MERCEDES
----------

### UTENSILI OEM

271589001500
271589003100
271589006100
271589014000

### CODICE MOTORE

271.820	271.948
271.860	271.950
271.861	271.951
271.910	271.952
271.911	271.954
271.921	271.955
271.940	271.956
271.941	271.957
271.942	271.958
271.943	
271.944	
271.946	

## 53272

 2.10  -  5  160

KIT DI ATTREZZI DI ALLINEAMENTO  
PER MERCEDES BENZ AMG 156



### MODELLO

MERCEDES SERIES AMG

### UTENSILI OEM

156589003200

156589006100

156589006900

156589016300

### CODICE MOTORE

M156

M159

## 54738

 2.40  -  5  -

KIT DI STRUMENTI PER LA FASATURA  
DEGLI ALBERI A CAMME DEI MOTORI  
DIESEL



### MODELLO

A CLASS ( 2019)

B CLASS (2019)

C CLASS (2018)

CLA (2019)

CLS (2018)

E CLASS (2016)

GLB (2019)

GLC COUPE (2019)

GLE (2019)

V CLASS (2019)

VITO (2019)

### UTENSILI OEM

W654589

W654589004000

W654589014000

### CODICE MOTORE

1.6L 654.916

2.0L 654.920

## 53273

 1.00  -  10  320

KIT DI ATTREZZI DI REGOLAZIONE  
CINGHIA DENTATA PER MERCEDES  
M276, M157, M278



### MODELLO

MERCEDES

### UTENSILI OEM

276589014000

### CODICE MOTORE

152.980 276.952

157.980 276.954

157.981 276.955

157.982 276.956

157.983 276.957

157.984 276.958

157.985 276.960

276.820 278.920

276.821 278.922

276.822 278.927

276.823 278.928

276.824 278.929

276.825 278.932

276.850

276.853

276.950

## 54415

 1.60  5  10  240

KIT DI MESSA IN FASE PER MERCEDES M651



### MODELLO

A-CLASS 2012-2014, B-CLASS 2012-2014, C-CLASS  
2009-2014, C-CLASS COUPE 2011-2014, CLA 2013-  
2014, CLS 2011-2014, E-CLASS 2009-2014, E-CLASS  
COUPE/CABRIOLET 2009-2014, GLK 2008-2014,  
M-CLASS 2011-2014, S-CLASS 2010-2013, SLK 2012-  
2014, SPRINTER 2009-2014, V

DODGE CALIBER 2009-2011

JEEP COMPASS 2010-2014

### UTENSILI OEM

651589004000

651589014000

### CODICE MOTORE

1201634200 651.924

120634200 651.925

1211634200 651.940

651.901 651.955

651.910 651.956

651.911 651.957

651.912 651.960

651.913 651.961

651.916 651.980

651.922



## 54417

6.80 - 2 48

KIT DI MESSA IN FASE PER  
MERCEDES M133, M270, M274



### MODELLO

MERCEDES A-CLASS 176 1.6/2.0 2012-ON  
MERCEDES B-CLASS 242/246 1.6/2.0 2012-ON  
MERCEDES C-CLASS COUPÉ 1.6/2.0 2011-ON  
MERCEDES C-CLASS 204 1.6/2.0 2011-ON  
MERCEDES CLA 117 1.6/2.0 2012-ON  
MERCEDES E-CLASS 212 1.6/2.0 2011-ON

### UTENSILI OEM

270589006100

### CODICE MOTORE

M133  
M270  
M274

## 54416

0.86 5 10 240

KIT DI MESSA IN FASE PER  
MERCEDES M642



### MODELLO

C-CLASS 203/204 2004-2014, CLK 209 2005-2009,  
CLS 219/218 2005-2018, E-CLASS 211/212/213 2005-  
2018, E-CLASS COUPE/CABRIOLET 207 2009-2017,  
G-CLASS 461/463 2007-2015, GL-CLASS 164/166 2006-  
2016, GLE/GLE COUPE 166/292 2015-2020, GLK 204  
2008-2015, GLS 166 2016-2019

### UTENSILI OEM

642589003100

### CODICE MOTORE

642.820	642.856	642.921
642.822	642.858	642.922
642.826	642.861	642.930
642.830	642.862	642.932
642.832	642.867	642.940
642.834	642.868	642.950
642.835	642.870	642.960
642.836	642.872	642.961
642.838	642.884	642.970
642.850	642.886	642.975
642.852	642.890	642.990
642.853	642.896	642.992
642.854	642.910	642.993
642.855	642.920	

## 54418

1.75 5 135

KIT DI MESSA IN FASE PER  
MERCEDES M112, M113



### MODELLO

C-CLASS 240/280 (202) 1998-ON, C-CLASS  
240/320 (203) 2000-ON, CL 500 (215) 1999-2007,  
CLK 320/430 (208) 1997-2003, CLK 240/320/500/55  
AMG (209) 1997-ON, CLS 500/55 AMG (219) 2005-ON,  
E-CLASS 240/280/320/430 (210) 1997-ON, E-CLASS  
240/320/500/E55 AMG (211)

### UTENSILI OEM

112589000100  
112589003200  
112589013200

### CODICE MOTORE

M112	112.940	112.975	113.968
M113	112.941	112.976	113.969
112.910	112.942	113.940	113.971
112.911	112.943	113.941	113.981
112.912	112.944	113.942	113.987
112.913	112.947	113.943	113.989
112.914	112.949	113.948	113.990
112.915	112.951	113.960	113.992
112.916	112.953	113.961	113.995
112.917	112.954	113.963	
112.920	112.955	113.964	
112.921	112.970	113.965	
112.922	112.972	113.966	
112.923	112.973	113.967	

## 54414

2.50 5 135

KIT DI MESSA IN FASE PER MERCEDES M651



### MODELLO

A CLASS (2012-2018)  
B CLASS (2012-2019)  
C CLASS (2009-2015), C CLASS (2014-2018)  
CLA COUPE (2013-2019)  
CLS (2011-2018)  
E CLASS (2009-2016)  
GLA (2014-2020)  
GLC (2015-2019)  
GLE (2015-2019)  
GLK (2008-2015)  
M CLASS (2011-2015)  
S CLASS (2010-2013), S CLASS (2013-2017)  
SLC (2016-2017)  
SLK (2012-2016)  
SPRINTER (2009-2018), SPRINTER (2018-)  
V CLASS (2014-)

VIANO (2010-2015)  
VITO (2010-2015), VITO (2014-)

### UTENSILI OEM

608 31 800 651589004000  
608 31 810 651589014000  
608 31 820 651589034000  
608 31 830 651589094000

### CODICE MOTORE

651.900	651.916	651.940	651.961
651.901	651.921	651.950	651.980
651.910	651.922	651.956	
651.911	651.924	651.957	
651.912	651.925	651.958	
651.913	651.930	651.960	

## 51488

0.25 5 100 2300

DISPOSITIVO BLOCCAGGIO ALBERO MOTORE / ALBERO PER RENAULT / NISSAN/DACIA/SUZUKI

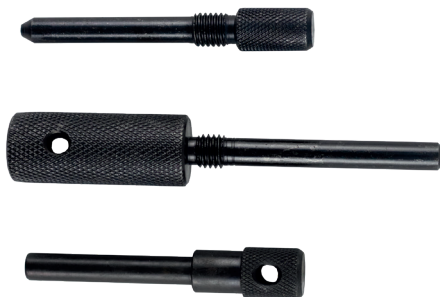

### MODELLO

CAPTUR 2013-2019, CLIOII, III, IV 1999-2019, ESPACE/GRANDESPEACEIII, IV 1999-2007, FLUENCE 2009-2015, KADJAR 2015-2018, KANGOO 1999-ON, LAGUNAI, II, III 1999-2015, LOGAN/LOGANMVCV 2006-2011, MEGANEI, I, II, IV 1997-2018, MODUS/GRANDMODUS 2004-2013, SCENIC/GRANDS

DACIA: DOKKER 2012-2018, DUSTER 2010-2018, LODGY 2012-2018, LOGAN 2005-2018, SANDERO 2008-2018

NISSAN: ALMERA 2002-2006, CUBE 2009-2011, JUKE 2010-ON, KUBISTAR 2003-2009, MICRA 2003-2019, NOTE 2006-2013, NV200/EVALIA 2009-2019, PRIMERA 2003-2007, QASHQAI (J10) 2007-ON, TIIDA 2007-2011, INTERSTAR 2002-2006, PRIMASTAR 2002-2007

SUZUKI: GRAND VITARA 2005-2015, JIMNY 2003-2011

### UTENSILI OEM

EN-52137	MOT1430	09919 58110	6075890015
KM6031	0132AJ1	09919 58120	9997122
MOT 1054	0187B	21263	
MOT 1489	0189B	3031277	
MOT 861	0194B	303735	
MOT 863	0991246510	49JE02021	

### CODICE MOTORE

F9Q 650	F9Q 674	F9Q 716	F9Q 722
F9Q 660	F9Q 680	F9Q 717	F9Q 730
F9Q 664	F9Q 690	F9Q 718	F9Q 731
F9Q 670	F9Q 710	F9Q 720	F9Q 732

F9Q 733	F9Q 826	K9K 704	K9K 800
F9Q 734	F9Q 870	K9K 706	K9K 802
F9Q 736	F9Q 872	K9K 710	K9K 804
F9Q 740	F9Q B2	K9K 712	K9K 806
F9Q 744	K9K 262	K9K 714	K9K 808
F9Q 748	K9K 266	K9K 716	K9K 812
F9Q 750	K9K 276	K9K 718	K9K 816
F9Q 751	K9K 299	K9K 722	K9K 820
F9Q 752	K9K 400	K9K 724	K9K 826
F9Q 754	K9K 500	K9K 728	K9K 830
F9Q 755	K9K 608	K9K 729	K9K 832
F9Q 758	K9K 609	K9K 732	K9K 834
F9Q 759	K9K 612	K9K 734	K9K 836
F9Q 760	K9K 626	K9K 740	K9K 837
F9Q 762	K9K 628	K9K 750	K9K 838
F9Q 770	K9K 629	K9K 752	K9K 842
F9Q 772	K9K 636	K9K 760	K9K 846
F9Q 774	K9K 638	K9K 762	K9K 856
F9Q 780	K9K 639	K9K 764	K9K 858
F9Q 782	K9K 646	K9K 766	K9K 872
F9Q 790	K9K 647	K9K 768	K9K 884
F9Q 800	K9K 656	K9K 770	K9K 892
F9Q 803	K9K 657	K9K 772	K9K 894
F9Q 804	K9K 658	K9K 774	K9K 896
F9Q 808	K9K 666	K9K 780	K9K 898
F9Q 812	K9K 667	K9K 782	
F9Q 814	K9K 676	K9K 790	
F9Q 816	K9K 677	K9K 792	
F9Q 818	K9K 700	K9K 794	
F9Q 820	K9K 702	K9K 796	

## 54593

4.00 - 2 48

KIT DI TEMPORIZZAZIONE TWIN PER MOTORI RENAULT 1.4, 1.6, 1.8, 2.0 16 V

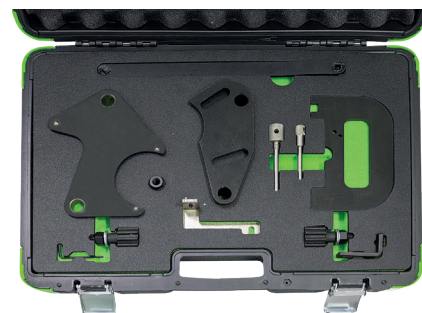

### MODELLO

1999 RENAULT MÉGANE, SCÉNIC, CLIO III, KANGOO, KANGOO II, LAGUNA

1999-2003 RENAULT SCENIC, RENAULT KANGOO II, DACIA LOGAN

1999-2008 RENAULT CLIO II, MEGANE, SCENIC, SCÉNIC

2001-2005 RENAULT LAGUNA

2002-2008 RENAULT MÉGANE

2003-2009 RENAULT LAGUNA

2003-2010 RENAULT MEGANE II, SCÉNIC, RENAULT CLIO II, RENAULT THALIA

2004-2010 RENAULT CLIO III, RENAULT MODUS, RENAULT GRAND MODUS

2006-2007 RENAULT LAGUNA

2010 DACIA DUSTER, DACIA LOGAN, DACIA SANDERO

### UTENSILI OEM

KM-6031	MOT 1509-01
KM-6233	MOT 1750
MOT 1054	MOT 1801
MOT 1489	MOT 861
MOT 1490-01	
MOT 1496	

### CODICE MOTORE

F4P	K4M
F4R	K9K
K4J	

## 53290

1.90 - 5 165

KIT DI ATTREZZI DI REGOLAZIONE CINGHIA DENTATA PER RENAULT/VOLVO 16V, 20V



### MODELLO

RENAULT: LAGUNA 2.0 16V / 2.5 20V (1996-1999), SAFRANE 2.0 16V / 2.5 20V (1996-2001)

VOLVO: 850 (1992-1997), C70 (1998-2002), S40 (1996-2004), V40 (1996-2004), S60 (2001-2005), S70 (1997-2000), S80 (1999-2005)

### UTENSILI OEM

MOT 1337
MOT 1340
MOT 1348
303-1178
303-1182
999 5451
999 5452

### CODICE MOTORE

B4164S	B4204T2	B5234T4	B5254S
B4164S2	B4204T3	B5234T7	B5254T
B4184S	B4204T5	B5234T9	B5254T2
B4184S2	B5204T	B5244S	B5254T4
B4184S3	B5204T2	B5244S2	N7Q700
B4184S9	B5204T3	B5244SG	N7Q704
B4194T2	B5204T4	B5244SG3	N7Q710
B4204S	B5204T5	B5244T	N7Q711
B4204S2	B5234T	B5244T3	
B4204T	B5234T3	B5244T7	

## 53289

1.50 5 10 240

KIT DI ATTREZZI DI REGOLAZIONE CINGHIA DENTATA PER RENAULT 1.4, 1.6, 1.8, 2.0 16V

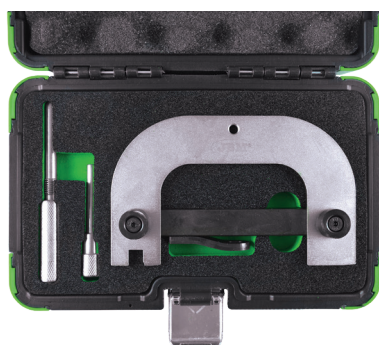

### MODELLO

DACIA LOGAN / MCV (05-11)  
 ESPACE / GRAND ESPACE (98-02), ESPACE / GRAND ESPACE IV (02-10) KANGOO/TREKKA (01-09), LAGUNA (98-01), LAGUNA II (01-07), LAGUNA III (07-13), MEGANE (99-03), MEGANE II (02-10) MEGANE III/SPORT (08-13), MEGANE / SCENIC (99-00), SCENIC / RX4 (99-03)  
 NISSAN KUBISTAR X76 (03-09), PRIMASTAR (02-11)  
 OPEL JETTA, TOURAN, GOLF, GOLF PLUS, POLO, PASSAT, TIGUAN, SCIROCCO  
 SCENIC / GRAND SCENIC III (03-09), TRAFIC II (01-11) TWINGO II (08-14), VEL SATIS (00-10), WIND (10-14)

### UTENSILI OEM

KM6031	MOT 863
MOT 1054	09912 46510
MOT 1489	0991958110
MOT 1496	6031
MOT 1496/1750	607589001500
MOT 861	

### CODICE MOTORE

F4P720	F4R701	F4R738	F4R791
F4P722	F4R712	F4R740	F4R792
F4P760	F4R713	F4R741	F4R820
F4P770	F4R714	F4R744	F4R830
F4P771	F4R715	F4R746	F4R832
F4P772	F4R720	F4R747	F4Rt720
F4P773	F4R722	F4R770	F4Rt722
F4P774	F4R730	F4R771	F4Rt760
F4P775	F4R732	F4R780	F4Rt761
F4R700	F4R736	F4R790	F4Rt762

F4Rt763	K4J711	K4M720	K4M800
F4Rt764	K4J712	K4M724	K4M801
F4Rt765	K4J713	K4M730	K4M802
F4Rt766	K4J714	K4M732	K4M804
F4Rt767	K4J715	K4M734	K4M812
F4Rt774	K4J730	K4M736	K4M813
F4Rt776	K4J732	K4M740	K4M824
F4Rt784	K4J740	K4M742	K4M830
F4Rt786	K4J750	K4M743	K4M831
F4Rt787	K4J770	K4M744	K4M834
F4Rt794	K4J780	K4M745	K4M835
F4Rt795	K4M606	K4M746	K4M836
F4Rt796	K4M616	K4M748	K4M838
F4Rt797	K4M642	K4M750	K4M839
F4Rt800	K4M646	K4M752	K4M842
F4Rt802	K4M690	K4M753	K4M846
F4Rt810	K4M696	K4M754	K4M848
F4Rt811	K4M697	K4M760	K4M854
F4Rt813	K4M700	K4M761	K4M856
F4Rt820	K4M701	K4M762	K4M858
F4Rt867	K4M704	K4M764	K4M862
F4Rt870	K4M706	K4M766	K4M864
F4Rt872	K4M708	K4M768	K4M866
F4Rt874	K4M709	K4M776	K4M896
F4Rt886	K4M710	K4M782	
F4Rt887	K4M711	K4M788	
F4Rt896	K4M712	K4M790	
F4Rt897	K4M714	K4M791	
K4J700	K4M716	K4M792	
K4J710	K4M718	K4M794	

## 53292

2.35 - 5 165

KIT DI ATTREZZI DI REGOLAZIONE CINGHIA DENTATA PER RENAULT / OPEL 2.2, 2.5 TDI DCI



### MODELLO

OPEL VIVARO, MOVANO DIESEL, ASTRAB, VECTRA B, SIGNUM, ZAFIRA  
 RENAULT LAGUNA II, ESPACE, MASTER, TRAFIC, 2.2 / 2.5 DCI

### UTENSILI OEM

KM 6077	MOT 1536
KM 6148	MOT 1537
KM 6203	MOT 1538
KM 6204	6204
KM 6205	6205
MOT 1534	

### CODICE MOTORE

G9T600	G9T743
G9T605	G9T744
G9T606	G9T750
G9T607	G9U630
G9T642	G9U632
G9T645	G9U650
G9T700	G9U720
G9T702	G9U724
G9T703	G9U726
G9T706	G9U730
G9T707	G9U750
G9T710	G9U754
G9T720	Z22SE
G9T722	Z22YH

## 53291

2.50 - 5 165

KIT DI ATTREZZI DI REGOLAZIONE CINGHIA DENTATA PER RENAULT



### MODELLO

RENAULT CLIO, LAGUNA, MEGANE

### UTENSILI OEM

KM6031	MOT 1496	MOT1750
MOT 1054	MOT 1750	0991246510
MOT 1489	MOT 861	0991958110
MOT 1490-01	MOT 863	

### CODICE MOTORE

F4P720	F4P771	F4P775	F4Rt887
F4P722	F4P772	F4Rt870	F4Rt896
F4P760	F4P773	F4Rt872	F4Rt897
F4P770	F4P774	F4Rt886	K4J700

K4J710	K4M690	K4M734	K4M794
K4J711	K4M696	K4M736	K4M800
K4J712	K4M697	K4M740	K4M824
K4J713	K4M700	K4M742	K4M830
K4J714	K4M701	K4M743	K4M831
K4J715	K4M704	K4M744	K4M834
K4J730	K4M706	K4M760	K4M846
K4J732	K4M708	K4M761	K4M848
K4J740	K4M709	K4M764	K4M854
K4J750	K4M718	K4M766	K4M858
K4J770	K4M720	K4M776	K4M862
K4M 606	K4M724	K4M790	K4M866
K4M 782	K4M730	K4M791	
K4M616	K4M732	K4M792	

## 54210

1.80 - 5 135

KIT DI ATTREZZI DI BLOCCAGGIO DELLA RUOTA DENTATA DELL'ALBERO A CAMME PER FORD RENAULT 1.8, 2.0 16V



### MODELLO

RENAULT LAGUNA II (2001-2009) MEGANE II (2002-2009), SCENIC (2002-2009)

### UTENSILI OEM

MOT 1509  
MOT 1509-01

### CODICE MOTORE

F4P  
F4R  
F4RT776  
F4RT784  
F4RT786  
F4RT787  
F4R770  
F4R771

## 53311

2.55 - 5 165

KIT DI MESSA IN FASE RENAULT/NISSAN/OPEL/VAUXHALL 1.6, 2.0, 2.3 DCI



### MODELLO

MERCEDES-BENZ: C-CLASS 2014-2018  
NISSAN: NV400 2011-2019, PRIMASTAR 2006-2015, QASHQAI/QASHQAI+2 2007-2014, QASHQAI 2014-ON, X-TRAIL II 2007-2014, X-TRAIL III 2014-ON  
RENAULT: ESPACE/GRAND ESPACE IV 2006-2015, ESPACE V 2015-2018, FLUENCE 2013-2015, KADJAR 2015-2018, KOLEOS 2008-2016, KOLEOS II 2017-2019, LAGUNA II 2005-2007, LAGUNA III 2007-2015, LATITUDE 2010-2016, MASTER III 2010-2019, MEGANE II 2006-2010, MEGANE III  
VAUXHALL/OPEL: MOVANO-B 2010-2019, VIVARO-A 2006-2014, VIVARO-B 2014-2019

### CODICE MOTORE

EN 48330	KM6130	MOT 1970
EN 48331	MOT 1766	09953 05010
EN 48334	MOT 1769	48332
EN-48332	MOT 1770	626589001500
EN-51241	MOT 1773	626589024000
EN-955-2	MOT 1969	626589044000

### CODICE MOTORE

622.951	M9R 630	M9R 740
626.951	M9R 692	M9R 742
M9R	M9R 700	M9R 744
M9R 610	M9R 721	M9R 746
M9R 613	M9R 722	M9R 748
M9R 615	M9R 724	M9R 750

M9R 754	M9R 833	M9T 700
M9R 756	M9R 834	M9T 702
M9R 760	M9R 835	M9T 704
M9R 761	M9R 836	M9T 706
M9R 762	M9R 838	M9T 708
M9R 763	M9R 839	M9T 710
M9R 780	M9R 844	M9T 870
M9R 782	M9R 845	M9T 880
M9R 784	M9R 846	M9T 890
M9R 786	M9R 849	M9T 892
M9R 788	M9R 854	M9T 896
M9R 800	M9R 855	M9T 898
M9R 802	M9R 856	R9M
M9R 803	M9R 857	R9M 402
M9R 804	M9R 858	R9M 404
M9R 805	M9R 859	R9M 408
M9R 806	M9R 864	R9M 409
M9R 808	M9R 865	R9M 410
M9R 809	M9R 866	R9M 413
M9R 811	M9T 670	R9M 414
M9R 812	M9T 672	R9M 415
M9R 814	M9T 676	R9M 450
M9R 815	M9T 678	R9M 452
M9R 816	M9T 680	R9M 453
M9R 817	M9T 686	
M9R 820	M9T 690	
M9R 824	M9T 692	
M9R 828	M9T 694	
M9R 830	M9T 696	
M9R 832	M9T 698	

## 54289

1.40 - 5 10 240

KIT BLOCCAGGIO VOLANO MOTORE PER MERCEDES/RENAULT/DACIA/NISSAN



### MODELLO

DACIA DOKER 2015 +  
DACIA DUSTER 2015+  
DACIA LODGY 2015+  
DACIA LOGAN 2013/-2020  
DACIA SANDERO 2013+  
MERCEDES-BENZ A-CLASS 2018+  
MERCEDES-BENZ B-CLASS 2019+  
MERCEDES-BENZ CLA 2019+  
MERCEDES-BENZ GLA 2019+  
MERCEDES-BENZ GLB 2019+  
RENAULT ARKANA 2019+  
RENAULT CAPTUR 2018+  
RENAULT CLIO V 2019 +  
RENAULT KADJAR 2018+

RENAULT MEGANE IV 2017+  
RENAULT SCENIC/GRAND SCENIC IV 2018+  
RENAULT TALISMAN 2018+

### UTENSILI OEM

MOT.2188

### CODICE MOTORE

HR13DDT	H4M 738
H4Bt 400	H4M 740
H4Bt 408	H5H 450
H4Bt 410	H5H 470
H4Bt 411	H5H 480
H4M 730	282.914

### 53523

2.50 - 5 165

KIT DI BLOCCAGGIO PER MOTORI DIESEL RENAULT/NISSAN/OPEL 1.6, 2.0, 2.3 DCI



#### MODELLO

MERCEDES-BENZ: C-CLASS 2014-2018  
 NISSAN: NV400 2011-2019, PRIMASTAR 2006-2015,  
 QASHQAI/QASHQAI+2 2007-2014, QASHQAI 2014-ON,  
 X-TRAIL II 2007-2014, X-TRAIL III 2014-ON  
 RENAULT: ESPACE/GRAND ESPACE IV 2006-2015,  
 ESPACE V 2015-2018, FLUENCE 2013-2015, KADJAR  
 2015-2018, KOLEOS 2008-2016, KOLEOS II 2017-2019,  
 LAGUNA II 2005-2007, LAGUNA III 2007-2015, LATITUDE  
 2010-2016, MASTER III 2010-2019, MEGANE II 2006-2010,  
 MEGANE III  
 VAUXHALL/OPEL: MOVANO-B 2010-2019, VIVARO-A  
 2006-2014, VIVARO-B 2014-2019

#### UTENSILI OEM

EN 48330	KM6130	MOT 1970
EN 48331	MOT 1766	09953 05010
EN 48334	MOT 1769	48332
EN-48332	MOT 1770	626589001500
EN-51241	MOT 1773	626589024000
EN-955-2	MOT 1969	626589044000

#### CODICE MOTORE

622.951	M9R	M9R 613	M9R 630
626.951	M9R 610	M9R 615	M9R 692

M9R 700	M9R 806	M9R 856	M9T 890
M9R 721	M9R 808	M9R 857	M9T 892
M9R 722	M9R 809	M9R 858	M9T 896
M9R 724	M9R 811	M9R 859	M9T 898
M9R 740	M9R 812	M9R 864	R9M
M9R 742	M9R 814	M9R 865	R9M 402
M9R 744	M9R 815	M9R 866	R9M 404
M9R 746	M9R 816	M9T 670	R9M 408
M9R 748	M9R 817	M9T 672	R9M 409
M9R 750	M9R 820	M9T 676	R9M 410
M9R 754	M9R 824	M9T 678	R9M 413
M9R 756	M9R 828	M9T 680	R9M 414
M9R 760	M9R 830	M9T 686	R9M 415
M9R 761	M9R 832	M9T 690	R9M 450
M9R 762	M9R 833	M9T 692	R9M 452
M9R 763	M9R 834	M9T 694	R9M 453
M9R 780	M9R 835	M9T 696	
M9R 782	M9R 836	M9T 698	
M9R 784	M9R 838	M9T 700	
M9R 786	M9R 839	M9T 702	
M9R 788	M9R 844	M9T 704	
M9R 800	M9R 845	M9T 706	
M9R 802	M9R 846	M9T 708	
M9R 803	M9R 849	M9T 710	
M9R 804	M9R 854	M9T 870	
M9R 805	M9R 855	M9T 880	

### 54438

1.50 - 5 135

KIT DI MESSA IN FASE PER RENAULT/NISSAN 3.0DCI



#### MODELLO

NISSAN: NAVARA PICK UP, PATHFINDER, INFITI  
 RENAULT: LAGUNA, LATITUDE

#### UTENSILI OEM

MOT1874
MOT1880
MOT1970

#### CODICE MOTORE

V9X
V9X791
V9X891

### 54477

1.30 - 5 10 -

STRUMENTO PER LA FASATURA DIESEL OPEL/CHEVROLET SUZUKI 1.9 e 2.5 DTI - CDTI



#### MODELLO

CHRYSLER
DACIA
MITSUBISHI
OPEL
RENAULT

#### UTENSILI OEM

KM-603
KM-6031
KM-966

#### CODICE MOTORE

D4F 700	D4F 764	D7F 764	F8Q 736
D4F 702	D4F 770	D7F 766	F8Q 744
D4F 704	D4F 772	D7F 800	F8Q 770
D4F 706	D4Ft 780	D7F B700	F8Q 780
D4F 708	D4Ft 782	D7F C701	F8Q 782
D4F 712	D4Ft784	D7F706	F8Q 790
D4F 714	D4Ft786	E7J 626	F9Q 710
D4F 716	D7F 702	E7J 634	F9Q 730
D4F 722	D7F 704	E7J 635	F9Q 734
D4F 728	D7F 708	E7J 780	F9Q 744
D4F 730	D7F 710	F8Q 622	F9Q 770
D4F 732	D7F 720	F8Q 630	K7J 710
D4F 734	D7F 722	F8Q 632	
D4F 740	D7F 726	F8Q 720	
D4F 742	D7F 744	F8Q 722	
D4F 744	D7F 746	F8Q 731	

## 54225

2.20 - 5 135

KIT DI BLOCCAGGIO DELLA PULEGGIA DELL'ALBERO MOTORE/DEL VOLANO PER RENAULT/NISSAN



### MODELLO

NISSAN PRIMASTAR (06-15), QASHQAI/QASH-QAI+2(07-14), X-TRAIL (07-14), NAVARA (15-16) NV400 (11-16)  
 RENAULT ESPACE V (15-16), CLIO (06-16), FLUENCE (09-15), LAGUNA (05-15), LATITUDE (10-15), MEGANE (06-15), SCENIC/GRAND SCENIC (06-15), SPACE/GRAND ESPACE IV (02-15), KOLEOS (08-16), TRAFIC II (07-15), VEL SATIS (00-10), MASTER III (10-16)

### UTENSILI OEM

MOT 1431  
 MOT 1716  
 MOT 1789  
 MOT 2019  
 MOT 919-02

### CODICE MOTORE

2TR 700	M4R 711	M5M 400	M9R 726
2TR 702	M4R 713	M5M 450	M9R 730
2TR 703	M4R 714	M9S 615	M9R 735
2TR 704	M4R 737	M9R 610	M9R 740
2TR 705	M4R 746	M9R 613	M9R 742
2ZV 604	M4R 750	M9R 630	M9R 744
H4JT 700	M4R 751	M9R 700	M9R 746
M4R 700	M4R 752	M9R 721	M9R 748
M4R 701	M4R 753	M9R 722	M9R 750
M4R 704	M4R 754	M9R 724	M9R 756

M9R 760	M9R 833	M9T 698
M9R 761	M9R 834	M9T 700
M9R 762	M9R 835	M9T 702
M9R 763	M9R 836	M9T 706
M9R 780	M9R 838	M9T 708
M9R 782	M9R 839	M9T 870
M9R 784	M9R 844	M9T 880
M9R 786	M9R 845	M9T 890
M9R 788	M9R 846	M9T 896
M9R 800	M9R 849	M9T 898
M9R 802	M9R 854	M9T C6
M9R 803	M9R 855	V4U 604
M9R 804	M9R 856	V4Y 701
M9R 805	M9R 857	V4Y 711
M9R 806	M9R 858	V4Y 713
M9R 808	M9R 859	V4Y 715
M9R 809	M9R 865	VQ25
M9R 811	M9R 866	YS23DDT
M9R 812	M9T 670	YS23DDTT
M9R 814	M9T 672	
M9R 815	M9T 676	
M9R 816	M9T 678	
M9R 817	M9T 680	
M9R 820	M9T 686	
M9R 824	M9T 690	
M9R 828	M9T 692	
M9R 830	M9T 694	
M9R 832	M9T 696	

## 54439

1.10 10 50 240

BLOCCAGGIO PULEGGIA ALBERO MOTORE RENAULT/DACIA 0.9, 1.0, 1.2, 1.6 TCE



### MODELLO

DACIA: DOKKER 2012-2019, DUSTER 2013-2018, LODGY 2012-2018  
 RENAULT: CAPTUR 2013-2019, CLIO IV 2012-2019, KADJAR 2015-2018, KANGOOII 2013-ON, MEGANEIII 2012-2017, MEGANEIV 2016-2020, SCENIC/GRAND SCENICIII 2012-2017, SCENIC/GRAND SCENICIV 2016-2018, TWINGOOIII 2014-ON  
 SMART: FORTWO 2014-2019, FORFOUR 2014-2019

### UTENSILI OEM

MOT 2006  
 MOT 2054  
 281589004000

### CODICE MOTORE

281.910	H4BT 400	H4M440	H5F408
281.910(H4B)	H4BT 401	H4M729	H5F410
281.920	H4BT 408	H4M730	H5F412
281.920(H4D)	H4BT 410	H4M738	H5F400
H4B	H4BT 451	H4M740	H5FT 402
H4B 408	H4D	H4M748	H5FT 404
H4B 453	H4D 400	H4M749	H5FT 405
H4B400	H4D400	H5F	H5FT 408
H4B401	H4D450	H5F 408	H5FT 410
H4B408	H4D460	H5F 410	H5FT 412
H4B410	H4D470	H5F400	
H4B411	H4M	H5F403	
H4B451	H4M429	H5F404	
H4B453	H4M438	H5F405	

## 53300

1.25 - 10 270

KIT DI ATTREZZI DI REGOLAZIONE CINGHIA DENTATA PER OPEL/VAUXHALL/CHEVROLET 2,0CDI



### MODELLO

CHEVROLET  
 OPEL

### UTENSILI OEM

EN-48245  
 EN-48246  
 205083060

### CODICE MOTORE

LLWZ20DMH  
 RA420  
 Z20DM  
 Z20DMH  
 Z20SI  
 Z20S3  
 Z20S4  
 Z20S5

## 53299

6.70 - 2 42

KIT DI ATTREZZI DI REGOLAZIONE CINGHIA DENTATA PER OPEL/VAUXHALL



### MODELLO

1.3 CDTI 16V, 1.9 CDTI, 2.0 DTI, 2.2 DTI

### UTENSILI OEM

EN-46785 KM932  
EN-46788 KM933  
EN-46789 1860985000  
EN-49978  
KM927  
KM929

### CODICE MOTORE

A10XEP FD4  
A12XER FHYPHZ  
A13DTC FHZ  
A13DTE F13DTE5  
A13DTR LDV  
A13FD LUJ  
A14NEL LUVLDD  
A14XEL X10XE  
BAAA X12XE  
B12XEL X14XE  
B14NEH X16SEJ  
B14NEL X16XEL  
B14NET X18E1  
C20SEL X18XE  
D13A X18XE1  
D223L X20DTH

X20DTL 188A8.000  
X20XEV 188A9.000  
X22DTH 199A2.000  
X22XE 199A3.000  
Y13DT 199A9.000  
Y16XE 199B1.000  
Y20DTH 199B4.000  
Y20DTL 199B8.000  
Y22DTH 223A9.000  
Y22DTR 225A2.000  
Y22XE 263A2.000  
Z10XE 263A6.000  
Z10XEP 312A8.000  
Z12XE 312B1.000  
Z12XEP 312B2.000  
Z13DT 330A1.000  
Z13DTH 55266963  
Z13DTJ 955B2.000  
Z14XE  
Z14XEP  
Z16XE  
Z18XE  
Z18XEL  
Z19DT  
Z19DTH  
Z20LET  
Z22XE  
169A1.000

## 53305

3.60 - 2 42

KIT DI ATTREZZI DI REGOLAZIONE CINGHIA DENTATA PER SAAB/OPEL/VAUXHALL

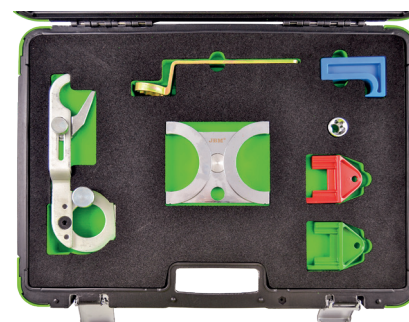

### MODELLO

SAAB 900 (93-98), 9000 (95-97), 9-5 (98-03)  
VAUXHALL / OPEL: ANTARA (06-10), CALIBRA (93-98),  
CAVALIER/VECTRA-A (93-95), OMEGA-B (94-03),  
SIGNUM (03-05), SINTRA (96-99), VECTRA-B (95-02),  
VECTRA-C (02-05)

### UTENSILI OEM

KM-800-1  
KM-800-10  
KM-800-2  
KM-800-20  
KM-800-30  
MKM-6038  
83 95 006

### CODICE MOTORE

B2581  
B308E  
B308i  
C25XE  
X25XE  
X30XE  
Y26SE  
Y32SE  
Z32SE

## 53301

1.15 - 5 - 10 240

KIT DI ATTREZZI DI REGOLAZIONE CINGHIA DENTATA PER SUZUKI/OPEL 1.0, 1.2, 1.4



### MODELLO

OPEL AGILA (00-08), ASTRA -G (98-06), CLASSIC II (03-10), ASTRA H (04-11), COMBO (04-12), CORSA B (97-00)  
CORSA C (00-07), CORSA D (06-12), MERIVA (04-10),  
TIGRA (04-10)  
SUZUKI WAGON R (05-08)

### UTENSILI OEM

EN 952  
EN 953 A  
EN 955 10  
EN/KM-952  
EN/KM-953-A  
EN-955-1  
KM 952  
KM 953

KM 953 A  
KM 954  
KM 955  
KM 955 01  
KM 955 1

### CODICE MOTORE

X12XE  
Z10XE  
Z10XEP  
Z10XEP  
Z12XE  
Z12XEP  
Z12XEP  
Z14XEL  
Z14XEP

## 53302

1.10 5 10 240

KIT DI ATTREZZI DI REGOLAZIONE CINGHIA DENTATA PER FIAT/ALFA ROMEO/VAUXHALL/OPEL/SAAB JTD



### MODELLO

ALFA ROMEO: 147 2002-2011, 156 2002-2008, 159 2005-2012, 166 2003-2008, BRERA 2005-2011, CROSSWAGON 2004-2008, GIULIETTA 2010-ON, GT 2004-2010, MITO 2008-2016, SPIDER 2006-2011, STELVIO 2017-UP  
CHRYSLER: DELTA 2011-2014

FIAT: 500L/500L LIVING/500L MPW 2013-ON, 500X 2014-ON, BRAVO 2007-2015, CROMA 2005-2011, DOBLO/CARGO/WORKUP 2010-ON, DUCATO 2011-2019, FREEMONT 2011-2016, IDEA 2008-2012, LINEA 2008-2011, PUNTO/GRANDE PUNTO 2008-2013, SEDICI 2009-2012, STILO 2004-2008, TI

JEEP: CHEROKEE 2015-2018, COMPASS 2017-ON, RENEGADE 2014-ON

LANCIA: DELTA 2008-2015, MUSA 2008-2012, THESIS 2003-2009

VAUXHALL/OPEL: ASTRA-H 2004-2011, ASTRA-J 2009-2015, CASCADA 2013-2015, COMBO-D 2012-2018, INSIGNIA-A 2008-2017, SIGNUM 2004-2008, VECTRA-C 2004-2008, ZAFIRA-B 2005-2012, ZAFIRA-C TOURER 2011-2015

### UTENSILI OEM

EN 46788	09917-68620	1 870 986 900
EN 46789	1 860 898 000	2 000 003 000
0188H	1 860 905 000	303-1667/2
0198-B	1 860 905 010	32 025 008
0198-B2	1 860 965 000	32 025 009
09912-37910	1 870 896 900	

### CODICE MOTORE

192A5.000	841M.000	940C4.000
192B1.000	841N.000	940C5.000
198A2.000	841P.000	955A3.000
198A3.000	844A1.000	955A4.000
198A5.000	844A2.000	A16DT/LJ5
198A6.000	844A3.000	A16DTH/LJ5
198A8.000	936B.000	A20DT/LBR
199A5.000	937A4.000	A20DT/LHZ
199B5.000	937A5.000	A20DTC/LCD
250A1.000	937A6.000	A20DTE/LHV
250A2.000	939A1.000	A20DTH/LBS
263A1.000	939A2.000	A20DTJ/LBX
263A3.000	939A3.000	A20DTL/LBQ
263A4.000	939A7.000	A20DTR/LBY
263A5.000	939A8.000	B16DT/LJ5
263A7.000	939A9.000	B16DTH/LJ5
263A8.000	939B3.000	D19AA
263A9.000	939B4.000	D20AA
350A2.000	939B5.000	EBT(55263087)
350A3.000	940A3.000	EBT(55263088)
46346359	940A4.000	EJK(55263113)
55260384	940A5.000	Z19DTH
55263087	940A7.000	Z19DTJ
55263088	940A8.000	
55263099	940B4.000	
55280444	940B5.000	
55283099	940B6.000	
55284064	940B9.000	
841G.000	940C1.000	
841H.000	940C3.000	

## 53307

0.98 5 10 240

KIT DI ATTREZZI DI REGOLAZIONE CINGHIA DENTATA PER ALFA/OPEL/VAUXHALL 1.6, 1.8 16V



### MODELLO

ALFA ROMEO 159  
CHEVROLET: AVEO, CRUZE, ORLANDO  
FIAT CROMA  
OPEL CORSA D, AGILA, ASTRA G-H, MERIVA, ZAFIRA B, VECTRA C, SIGNUM, INSIGNIA

### UTENSILI OEM

EN 6130	EN/KM 6625	2000012000
EN 6333	KM 6130	2000012100
EN 6340	KM 6333	2000012800
EN 6349	KM 6340	911
EN 6625	KM 6349	
EN 6628A	KM 6625	
EN/KM 6333	KM 6628 A	
EN/KM 6340	KM 911	

### CODICE MOTORE

2HO/A18XEL	G14D	Z16LEL
2HO/A18XER	LDE/A16XER	Z16LER
2HO/Z18XER	LDE/B16XER	Z16LET
939A4.000	LDE/F16D4	Z16XE1
A16LEL	LGE/A16XNT	Z16XEP
A16LER	LGE/B16XNT	Z16XER
A16LES	LLU/A16LET	Z16XNT
A16XER	LLU/B16LER	Z18XER
A16XNT	LUW	
A18XER	LXV/F16D4	

## 53316

0.70 - 10 -

STRUMENTO DI BLOCCAGGIO ALBERO A CAMME FIAT/OPEL/VAUXHALL 2.2 16V TRASMISSIONE A CATENA



### MODELLO

FIAT CROMA  
NISSAN: INTERSTAR 2002-2011, PRIMASTAR 2003-2012  
RENAULT: ESPACE/GRAND ESPACE 2000-2002, ESPACE/GRAND ESPACE IV 2002-2009, LAGUNA II 2002-2007, MASTER II 2000-2011, TRAFIC II 2002-2012, VEL SATIS 2000-2009  
VAUXHALL/OPEL: MOVANO-A 2000-2010, VIVARO-A 2002-2012, ASTRA-G 2000-2006, ASTRA-H 2006-2011, SIGNUM 2003-2008, VECTRA-B 2000-2002, VECTRA-C 2002-2008, VX220/SPEEDSTER 2000-2006, ZAFIRA-A 2000-2005, ZAFIRA-B 2005-2012

### UTENSILI OEM

KM-6077	194A1000
KM-6148	2.000.000.900

### CODICE MOTORE

194A1.000	G9T 710	G9U 724
G9T 600	G9T 720	G9U 726
G9T 605	G9T 722	G9U 730
G9T 606	G9T 742	G9U 750
G9T 607	G9T 743	G9U 754
G9T 642	G9T 744	Z22SE
G9T 645	G9T 750	Z22YH
G9T 700	G9U 630	
G9T 702	G9U 630	
G9T 703	G9U 632	
G9T 706	G9U 650	
G9T 707	G9U 720	



## 53317

0.64 - 12

FERMO PIGNONE POMPA DEL LIQUIDO DI RAFFREDDAMENTO OPEL/VAUXHALL 2.2



### MODELLO

FIAT: CROMA 2005-2011  
 NISSAN: INTERSTAR 2002-2011, PRIMASTAR 2003-2012  
 RENAULT: ESPACE/GRAND ESPACE 2000-2002, ESPACE/GRAND ESPACEIV 2002-2009, LAGUNA II 2002-2007, MASTER II 2000-2011, TRAFIC II 2002-2012, VEL SATIS 2000-2009  
 VAUXHALL/OPEL: MOVANO-A 2000-2010, VIVARO-A 2002-2012, ASTRA-G 2000-2006, ASTRA-H 2006-2011, SIGNUM 2003-2008, VECTRA-B 2000-2002, VECTRA-C 2002-2008, VX220/SPEEDSTER 2000-2006, ZAFIRA-A 2000-2005, ZAFIRA-B 2005-2012

### UTENSILI OEM

KM-J-43651  
 83 96 103

### CODICE MOTORE

B207E	G9T 706	G9U 650
B207L	G9T 707	G9U 720
B207R	G9T 710	G9U 724
G9T 600	G9T 720	G9U 726
G9T 605	G9T 722	G9U 730
G9T 606	G9T 742	G9U 750
G9T 607	G9T 743	G9U 754
G9T 642	G9T 744	Z20NET
G9T 645	G9T 750	Z22SE
G9T 700	G9U 630	Z22YH
G9T 702	G9U 630	194A1.000
G9T 703	G9U 632	

## 53452

0.80 5 10 240

KIT DI ATTREZZI DI REGOLAZIONE CINGHIA DENTATA PER OPEL/FORD/FIAT/ALFA ROMEO/LANCIA/SUZUKI



### MODELLO

FIAT, ALFA ROMEO, LANCIA 1.3 JTD MULTIJET  
 FORD 1.3 TDCI  
 OPEL AGILA, CORSA, COMBO (03-08), ASTRA H (05-08), MERIVA, TIGRA B (04-08)  
 SUZUKI 1.3 DDIS IGNIS, WAGON R (03-08), SWIFT (04-08)

### UTENSILI OEM

EN46781	0189B	21263
EN46785	0194B	3031277
EN-52137	0991238300	3031472
MOT.1430	0991768610	303735
MOT1430	0991958120	49JE02021
0104A	104A	607589011500
0132AJ1	1860985000	9997122
0187B	1871000900	

### CODICE MOTORE

167A1.000 (FD4)BAAA/B	DV4TD(8HZ)
169A1.000	DV4TED(8HS)
188A8.000	DV4TED4(8HX)
188A9.000	DV6(9HR)
199A3.000	DV6AT(9HX)
AZWA	DV6ATED(9HX)
BHPA	DV6ATED(9HY)
C9DA/B	DV6ATED4(9HX)
C9DC	DV6AUTED4(9HX)
DV4C(8HP)	DV6BTED4(9HT)
DV4C(8HR)	DV6BTED4(9HW)
DV4TD(8HT)	DV6BUTED4(9HT)
DV4TD(8HW)	DV6C(9HD)
DV4TD(8HX)	DV6C(9HL)

DV6C(9HR)	FFBA.G6DA
DV6C(BHX)	FHZ(F13DTE5)
DV6C(BHZ)	G6DA
DV6CATED(9HX)	G6DB
DV6CTED(9HC)	G6DC
DV6D(9HP)	G8DA
DV6DTED(9HF)	G8DB.HHDA
DV6DTED(9HJ)	HCBP
DV6DTED(9HP)	HCPA
DV6ETED(9HN)	HHDB
DV6TED(9HD)	HHJA
DV6TED(9HP)	HHJB
DV6TED4(9HV)	KKDA
DV6TED4(9HW)	MZ-CD
DV6TE-D4(9HX)	P7PA
DV6TED4(9HY)	P9PA
DV6TED4(9HZ)	QXWA
DV6TED4B	QXWB
DV6TED4B(9HV)	R2PA
DV6TED4BU(9HS)	R3PA
DV6UTED4(9HU)	RHE
DV6UTED4(9HX)	RTN
DV6TED4(8HV)	RTQ
DV6TED4(8HY)	RWPA
DV6TED4(9HV)	Y6
DW10CTED4	Z13DT
F13DTE5 (FHZ)	Z13DT
F6JA	Z13DTH
F6JB	Z13DTJ
F6JC	

## 53651

2.05 - 5 120

KIT DI ATTREZZI DI REGOLAZIONE CINGHIA DENTATA PER OPEL/VAUXHALL 1.0, 1.2, 1.4 TURBO



### MODELLO

OPEL ADAM, AMPERA, ASTRA J, AVEO, CORSA D, INSIGNIA, MERIVA B, MOKKA, ZAFIRA C TOURER

### UTENSILI OEM

EN 49977-100
EN 49977-200
EN 49978
KM 952
KM 953-A
KM 955-1
KM 955-2

### CODICE MOTORE

A10XEP (LDB)
A12XEL (L2G)
A12XER (LDC)
A14NEL (LDD)
A14NEL (LUH)
A14NEL (LUJ)
A14NET (LUJ)
A14XEL (L2Z)
A14XER (LDD)LDU
A14XER (LDU)
A14XFL (LUU)
12XEL (LWD)

## 54205

1.50 5 10 240

KIT DI ATTREZZI DI  
CRONOMETRAGGIO DEL MOTORE  
PER VAUXHALL/OPEL 1.6 CDTI



### MODELLO

VAUXHALL/OPEL: ASTRA J (13-18), ASTRA K, (15-19), GTC (15-18), INSIGNIA A (15-17), INSIGNIA- B (17-20), MERIVA B (13-17), MOKKA (14-16), MOKKA X (16-20), ZAFIRA C TOURER (13-19)

### UTENSILI OEM

EN-50513  
EN-51140  
EN-51143  
EN-51188  
EN-6130  
EN-6349

### CODICE MOTORE

B16DTC  
B16DTE  
B16DTH  
B16DTJ  
B16DTL  
B16DTN  
B16DTR  
B16DTU  
D16DTH  
D16DTI  
D16DTJ  
D16DTN  
D16DTR  
D16DTU

## 54214

1.80 - 5 135

KIT DI ATTREZZI DI  
CRONOMETRAGGIO DEL MOTORE  
PER OPEL/ISUZU 1.6D, 1.7D

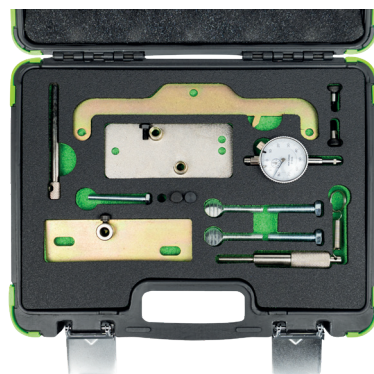

### MODELLO

OPEL/ISUZU: 1.6D, 1.7D

### UTENSILI OEM

KM 571A  
KM 661  
KM 661-2  
KM 851  
KM 951  
VAS 6079  
23-029  
3313  
6079

### CODICE MOTORE

TC4EE1  
X17DTL4EC1  
Y17DT  
Y17DTL17DR  
Z17DT  
4EC1  
4EE1  
4FC1  
4FD1  
4FG1  
4JA1  
4JB1  
4JG1  
4XJ1

## 54217

2.10 - 5 135

KIT DI ATTREZZI DI  
CRONOMETRAGGIO DEL MOTORE  
PER VAUXHALL/OPEL/SAAB 2.0, 2.2  
DTI



### MODELLO

SAAB 9-3 (98-04) 9-5 (02-06)  
VAUXHALL/OPEL ASTRA-G (98-06), FRONTERA-B (98-04), OMEGA-B, (98-03), SIGNUM (03-05), SINTRA (98-99), VECTRA-B (97-02), VECTRA-C (02-05), ZAFIRA-A (99-05)

### UTENSILI OEM

KM 927  
KM 929  
KM 932  
KM 933  
83 95 337  
83 95 352  
83 95 386  
83 95 394  
93 95 394

### CODICE MOTORE

D223L  
X20DTH  
X20DTL  
X22DYH  
Y20DTH  
Y20DTL  
Y22DTH  
Y22DTR

## 54221

2.80 - 5 135

KIT DI ATTREZZI CRONOMETRAGGIO DEL MOTORE PER VAUXHALL/OPEL 1.3  
CDTI



### MODELLO

OPEL 1.3 CDTI

### UTENSILI OEM

EN-46775  
EN-46785  
EN-50515  
EN-51500  
KM-662-C  
KM-955-1

### CODICE MOTORE

LKU B13DTE  
LKU B13DTR  
LKV B13DTC



## 54434

2.50 - 5 135

KIT DI MESSA IN FASE PER OPEL 1.0, 1.4, 1.5



### MODELLO

VAUXHALL/OPEL: ADAM (2014-2019), ASTRA-K (2015-2019), CORSA-E (2015-2019), INSIGNIA-B (2017-2020), MOKKA X (2016-2019), VIVA (2015-2020)

### UTENSILI OEM

EN-51298  
EN-51367  
EN-51632

### CODICE MOTORE

LE1/B10XFL	LE2/D14XFT
LE1/B10XFT	LFE/B14XNT
LE1/B10XHL	LFE/D14XNT
LE1/D10XFL	LFV/B15XHT
LE1/D10XFT	LFV/D15XHL
LE1/F10XFL	LFV/D15XHT
LE1/F10XFT	LV7/B14XE
LE2/B14XFL	LWT/B10XL
LE2/B14XFT	L5Q/B10XE
LE2/D14XFL	L5Q/D10XE

## 54435

0.15 10 100 -

KIT DI MESSA IN FASE PER OPEL/  
CHEVROLET/SAAB 1.4, 1.6, 1.8  
ECOTEC



### MODELLO

CHEVROLET: LACETTI (2005-2010), NUBIRA (2005-2010)  
OPEL/VAUXHALL: ASTRA-G (1998-2004), ASTRA-H (2004-2007), COMBO-C (2005-2012), CORSA-C (2000-2007), MERIVA-A (2003-2010), SIGNUM (2003-2007), TIGRA-B (2004-2010), VECTRA-B (1995-2002), VECTRA-C (2002-2008), ZAFIRA-A (1999-2005), ZAFIRA-B (2006-2013)  
SAAB: 9-3 (2003-2010)

### UTENSILI OEM

EN-852  
KM 6130  
KM 852  
KM 911

### CODICE MOTORE

F18D3	Y16XE
X14XE	Z14XE
X16SEJ	Z16XE
X16XEL	Z16YNG
X18E1	Z18XE
X18XE1	Z18XEL

## 54436

4.30 - 5 135

KIT DI MESSA IN FASE PER OPEL 1.6  
SIDI



### MODELLO

VAUXHALL: ASTRA-J (2013-2017), ASTRA-K (2015-2019), CASCADA (2013-2019), GTC (2015-2019), INSIGNIA (2013-2017), INSIGNIA-B (2018-2020), ZAFIRA-C TOURER (2014-2019)

### UTENSILI OEM

EN 50513  
EN 51147  
EN 51148  
EN 51153

### CODICE MOTORE

A16SHT	LVP/A16XHT
A16XHT	LVP/B16XHT
B16SHL	LWC/A16SHT
B16SHT	LWC/B16SHL
B16XHT	LWC/B16SHT
D16SHJ	LWC/D16SHJ
D16SHL	LWC/D16SHL
D16SHT	LWC/D16SHT

## 54437

4.45 - 2 48

KIT DI MESSA IN FASE PER OPEL/CHEVROLET/SAAB 2.0, 2.4



### MODELLO

CHEVROLET CAPTIVA (2011-2015), HHR (2008-2009), MALIBU (2012-2015)  
SAAB 9-3 (02-12) (2010-2012), 9-5 (10-12) (2010-2012)  
VAUXHALL/OPEL ANTARA (2011-2016), ASTRA-J (2012-2017), GTC (15-19) (2015-2019), INSIGNIA-A (08-17) (2008-2013)

### UTENSILI OEM

EN 43653	EN 49212
EN 45027	EN 49212 1
EN 45027 1	EN 49212 2
EN 48953	EN 955 10

EN45027 2	J 45027 1
EN-48585	J 45027 2
EN-955-20	KM 955
J 43653	KM 955-20

### CODICE MOTORE

A24XE (LE5)	LE9
A24XF (LE9)	LHU/A20NET
LDK/A20NHT	LHU/A20NFT
LE5	LHU/B20NFT

52271

 0.45  10  40  880

UTENSILI PER LA MESSA IN FASE DELLA DISTRIBUZIONE VAG

**MODELLO**

AUDI: A1/SPORTBACK 2010-2015, A2 2000-2006, A3/SPORTBACK 2002-2013, A4/QUATTRO/ALLROAD 2007-2015, A5/SPORTBACK 2008-2015, A6/QUATTRO 2002-2014, Q3 2011-2015, Q5 2008-2016, TT 2008-2014

SEAT: ALHAMBRA 2000-2015, ALTEA/ALTEA XL 2004-2015, CORDOBA 2002-2009, EXEO 2009-2013, IBIZA 2002-2015, LEON 2000-2013, TOLEDO 2000-2015

SKODA: FABIA 2003-2007, FABIA II 2007-2015, OCTAVIA/OCTAVIA TOUR 2002-2010, OCTAVIA II 2004-2013, PRAKTIK 2007-2015, RAPID/SPACEBACK 2012-2015, ROOMSTER 2006-2015, SUPERB 2005-2008, SUPERB II 2009-2015, YETI/OUTDOOR 2009-2017

VOLKSWAGEN: AMAROK 2010-2016, BEETLE 2002-2015, BORA 2002-2005, CADDY/CADDY MAXI 2004-2015, CRAFTER 2011-2017, EOS 2006-2015, FOX 2005-2011, GOLF PLUS 2005-2014, GOLF IV/ESTATE 2002-2006, GOLF V/ESTATE 2004-2009, GOLF VI/ESTATE 2008-2018, JETTA 2005-2016,

**UTENSILI OEM**

EN-51418	T10115	10122
MB995206	T20102	T14120
MB995208	T20167	23059
MB995231	T40011	303-1054
MPI301	T40098	310085
T03006	T40316	3204
T10050	U40074	3359
T10060	VM9882	9882
T10060A	VM9883	
T10100	0198-J	

**CODICE MOTORE**

AJM	BMP	BVG	CBDC	CJCB
AMF	BMR	BVH	CCHA	CJCC
ANU	BMS	BVK	CCHB	CJCD
ARL	BMT	BWB	CDBA	CKTB
ASZ	BNA	BWV	CDCA	CKTC
ATD	BNM	BXE	CEGA	CKUB
ATL	BNV	BXF	CFCA	CKUC
AUY	BPW	BJX	CFFA	CLCA
AVB	BPX	CAAA	CFFB	CLCB
AVF	BPZ	CAAB	CFFD	CLJA
AVF	BRB	CAAC	CFFE	CLLA
AWX	BRC	CAAD	CFGB	CLLB
AXB	BRD	CAAE	CFGC	CLNA
AXC	BRE	CAGA	CFGD	CLSC
AXR	BRF	CAGB	CFHA	CMEA
AZV	BRM	CAGC	CFHB	CMFA
BAY	BRR	CAHA	CFHC	CMFB
BGW	BRS	CAHB	CFHD	CMGA
BHC	BRT	CAYA	CFHE	CMGB
BHW	BSS	CAYB	CFHF	CNEA
BJB	BST	CAYC	CFJA	CNFA
BKC	BSV	CAYD	CFJB	CNFB
BKD	BSW	CAYE	CFWA	CSHA
BKP	BTB	CBAA	CGLA	CSLA
BLB	BUK	CBAB	CGLB	CSLB
BLS	BUY	CBAC	CGLC	CSNA
BLT	BUZ	CBBA	CGLD	
BMA	BVA	CBBB	CGLE	
BMM	BVE	CBDA	CJAA	
BMN	BVF	CBDB	CJCA	

54454

 6.25  -  2  40

KIT DI MESSA IN FASE PER AUDI 3.0 FSI/TFSI/RS

**MODELLO**

AUDI A6 (2018-2021), A8 (2017-2021), Q8 (2019-2021), RS4 (2017-2021), RS5 (2017-2021), S4 (2017-2020), S5 (2016-2020), SQ5 (2017-2020), RS4 (2017-2021)

**UTENSILI OEM**

T40331
T40331/1
T40331/2
T40331/4
T40331/5
T40331/9
T90000
T90001
T90002

**CODICE MOTORE**

CWGD
CZSA
CZSE
DCBD
DECA
DLZA

54455

 2.65  -  5  120

ESTRATTORE PULEGGIA ALBERO A CAMME VAG

**MODELLO**

AUDI: A3 2.0L TDI 2010-2015, A6 3.0L TDI QUATTRO 2014-2015, A8 3.0L TDI QUATTRO 2014-2015, Q5 3.0L TDI 2014-2015, Q7 3.0L TDI 2009-2015.

VW: BEETLE 1.9L TDI 1998/2005-2006, BEETLE 2.0L TDI 2013-2015, GOLF 1.9L TDI 1999/2004-2006, GOLF 2.0L TDI 2010-2015, JETTA 1.9L TDI 1997-2006, JETTA 2.0L TDI 2009-2015, TOUAREG 3.0L TDI 2009-2015.

**UTENSILI OEM**

T40001
T40001-6
T40001-7

**CODICE MOTORE**

AEB
AHA
AKB
ALH
APB
APH
ART
ATC
ATQ
ATW
AUG
AUM
AUX
AWD
AWN
AWP

## 51489

0.35 10 40 2250

ATTREZZO DI BLOCCAGGIO ALBERO A CAMME VAG 1.4, 1.6



### MODELLO

AUDI: 80 1982-1996, 90 1986-1991, 100 1978-1994, 200 1982-2001, A2 2000-2006, A3 1993-2010, A4/QUATTRO 1994-2008, A6/QUATTRO 1994-2002, CABRIOLET 1995-2000

SEAT: ALHAMBRA 1996-2010, ALTEA/ALTEA XL 2004-2013, AROSA 1999-2005, CORDOBA 1993-2009, EXEO 2009-2010, FABIA 1999-2007, IBIZA 1993-2015, INCA 1996-2004, LEON 1999-2013, OCTAVIA 1997-2012, TOLEDO 1994-2009

SKODA: FABIA 1999-2015, OCTAVIA 1997-2013, PRAKTIK 2007-2015, ROOMSTER 2006-2015, SUPERB 2001-2008

VOLKSWAGEN: BEETLE 1998-2011, BORA 1998-2005, CADDY 1980-2015, FOX 2005-2007, GOLF 1980-1999, GOLF2 1998-2013, JETTA 1980-1992, JETTA 2004-2017, LT 1982-1996, LUPO 1998-2005, PASSAT 1980-2010, POLO 1995-2014, SANTANA 1980-1988, SHARAN 1995-2010, TOURAN 20

### UTENSILI OEM

T10016  
T10074

### CODICE MOTORE

1,2 TDI PD	AFK	APE	AVU	BSW
1,4	AFN	APF	AVY	BSX
1,4 TDI PD	AGD	APK	AWH	BUD
1,6	AGP	AQM	AWX	CCSA
1,6 D Turbo	AGR	AQQ	AXA	CGGA
1,7 SDI	AHB	AQY	AXP	CGGB
1,9 SDI	AHF	ARC	AXR	CHGA
1,9 SDI/ TDI	AHG	ARL	AYD	CMAA
1,9 TDI	AHH	ARM	AYQ	CMXA
1,9 TDI PD	AHL	ARR	AYZ	CR
1G	AHU	ASV	AZD	CS
1S	AHW	ASX	AZH	CY
1V	AJA	ASY	AZJ	DV
1X	AJM	ASZ	AZM	DW
1Y	AJV	ATD	BAD	JK
1Z	AKL	ATJ	BBY	JP
2,0	AKQ	ATM	BBZ	JR
2,4 D	AKU	ATN	BCA	JX
AAB	AKW	AUA	BCB	KY
AAZ	ALE	AUB	BEH	ME
ABL	ALH	AUR	BFQ	RA
ACL	ALZ	AUS	BFS	SB
ACT	AMF	AUY	BGU	
AEF	ANA	AVB	BKY	
AEH	ANU	AVF	BSE	
AEY	ANY	AVG	BSF	

## 53274

0.95 5 10 240

KIT DI ATTREZZI DI REGOLAZIONE CINGHIA DENTATA PER VOLKSWAGEN/SEAT/SKODA 1,2L



### MODELLO

SEAT IBIZA, CORDOBA  
SKODA FABIA  
VOLKSWAGEN LUPO, POLO, EOS, FOX

### UTENSILI OEM

T10120  
T10121  
T10123

### CODICE MOTORE

AWY  
AZQ  
BBM  
BMD  
BME  
BXV  
BZG  
CEVA  
CGPA  
CGPB  
CGPC  
CHFA  
CHFB

## 53278

4.75 2 48

KIT DI ATTREZZI DI REGOLAZIONE CINGHIA DENTATA PER AUDI 2.8, 3.2 FSI, 3.0 TFSI



### MODELLO

VAG 2.5, 2.8, 3.2 FSI, 3.0 TFSI

### UTENSILI OEM

T10035  
T10172  
T10172/2  
T40058  
T40069  
T40071  
T40133  
T40133/1  
T40133/1/2  
T40133/2  
3212

### CODICE MOTORE

BDX	CGXB	CNYA
CAJA	CGXC	CPAA
CAKA	CHMA	CREA
CALA	CHMB	CREC
CALB	CHVA	CRED
CCAA	CJBA	CTTA
CCDA	CJTA	CTUA
CCEA	CJTB	CTUD
CGEA	CJTC	CTVA
CGFA	CJWC	CTWA
CGWA	CLXB	CTWB
CGWB	CMDA	CTXA
CGWC	CMUA	M06/EC
CGWD	CNAA	

## 53275

 0.70  5  10  240

## KIT DI ATTREZZI DI REGOLAZIONE CINGHIA DENTATA PER VW-AUDI



## MODELLO

AUDI: A1 (10-15), A2 (00-06), A3 (01-13), A4/ALLROAD (01-16), A5 (08-15), A6 (11-14), TT (08-14), Q3 (11-15), Q5 (08-15), A6 (10-14)

DODGE CALIBER (06-11)

FORD GALAXY (02-06)

MITSUBISHI GRANDIS (05-10), LANCER (05-10), OUTLANDER (07-10)

SEAT: ALHAMBRA (00-15), ALTEA/ALTEA XL (04-15), CORDOBA (02-09), IBIZA (02-15), LEON (00-13), TOLEDO (04-11)

SKODA: FABIA (00-14), FABIA II (07-15), OCTAVIA (00-10), OCTAVIA II (04-15), PRACTIK (10-15), RAPID (11-15), ROOMSTER (07-15), SUPERB (02-08), SUPERB II (08-15), YETI (09-14)

TOURAN (03-15), TRANSPORTER (03-17)

VOLKSWAGEN: AMAROK (10-16), BEETLE (02-15), BORA (02-08), CADDY/MAXI (03-15), EOS (06-15), FOX (05-11), GOLF (02-15), GOLF PLUS (05-14), JETTA (05-15), LUPO (02-05), PASSAT/CC (02-15), POLO (99-14), SCIROCCO (08-14), SHARAN (02-15), TIGUAN (07-15)

## UTENSILI OEM

EN-51418	T10115	11 4 120
MB995206	T20102	23 059
MB995208	T20167	303-1054
MB995231	T40098	310 085
MP 1 301	T40316	3204
T03006	U40074	3359
T10050	VM 9882	9882
T10060	VM 9883	
T10060A	0198-J	
T10100	10122	

## CODICE MOTORE

AJM	BMS	BVK	CCHA	CJCC
AMF	BMT	BWB	CCHB	CJCD
ANU	BNA	BWD	CDBA	CKTB
ARL	BNM	BWV	CDCA	CKTC
ASZ	BNV	BXE	CEGA	CKUB
ATD	BPW	BXF	CFCA	CKUC
ATL	BPX	BXJ	CFFA	CLCA
AUY	BPZ	CAAA	CFFB	CLCB
AVB	BRB	CAAB	CFFD	CLJA
AVF	BRC	CAAC	CFFE	CLJA
AWX	BRD	CAAD	CFGB	CLLA
AXB	BRE	CAAE	CFGC	CLLB
AXC	BRF	CAGA	CFGD	CLNA
AXR	BRM	CAGB	CFHA	CLSC
AZV	BRR	CAGC	CFHB	CMEA
BAY	BRS	CAHA	CFHC	CMFA
BGW	BRT	CAHB	CFHD	CMFB
BHC	BSS	CAYA	CFHE	CMGA
BHW	BST	CAYB	CFHF	CMGB
BJB	BSV	CAYC	CFJA	CNEA
BKD	BSW	CAYD	CFJB	CNFA
BKP	BTB	CAYE	CFWA	CNFB
BLB	BUK	CBAA	CGLA	CSHA
BLS	BUY	CBAB	CGLB	CSLA
BLT	BUZ	CBAC	CGLC	CSLB
BMA	BVA	CBBA	CGLD	CSNA
BMM	BVE	CBBB	CGLF	
BMN	BVF	CBDA	CJAA	
BMP	BVG	CBDB	CJCA	
BMR	BVH	CBDC	CJCB	

## 53276

 5.30  -  2  40

## KIT DI ATTREZZI DI REGOLAZIONE CINGHIA DENTATA PER AUDI &amp; SKODA



## MODELLO

2.0, 2.8, 3.0

## UTENSILI OEM

T10008	T10120	3078
T10016	T10121	3242
T10020	T10123	3359
T10050	T10264	3366
T10060A	T10265	3369
T10092	T40011	3418
T10098	2064	3458
T10100	2065A	3551

## CODICE MOTORE

ACV	AXC	BMN
AHY	AXG	BMP
AJ	AXL	BMS
AJM	AXR	BNM
AMF	AYC	BNV
ANU	AYZ	BRM
ANY	AZU	BRU
ARL	AZV	BST
ASZ	BAY	BSU
ATD	BDJ	BTB
ATJ	BDK	BVK
ATL	BGW	BWB
AUY	BHC	BXE
AVB	BHW	BXF
AVQ	BJB	
AVX	BKC	
AWX	BKD	
AXB	BMM	

## 53280

 3.50  -  5  165

## KIT DI ATTREZZI PER LA MESSA IN FASE VAG 3.0 V6



## MODELLO

AUDI: A4/QUATTRO/CABRIO 2001-2008, A6/QUATTRO 2001-2008, A8 2001-2008

## UTENSILI OEM

T40011
T40026
T40028
T40030
3387

## CODICE MOTORE

ASN
AVK
BBJ
BGN



## 53277

1.60 - 5 165

GIOCO DI CHIAVI PER TENDITORE CINGHIA DI DISTRIBUZIONE VW E AUDI



### MODELLO

1,2 TDI, 1,4 TDI, 1,5 D, 1,6D, 1,7 SDI, 1,9 TDI, 2,0 TDI, 2,5 TDI  
1,6L, 1,8L, 1,8LT, 1,8LT 16V, 2,0L, 2,0L 16V, 2,0L FSI/TSI

### UTENSILI OEM

T10020	T100604	T40011	3387
T10060	T10115	V159	

### CODICE MOTORE

AAB	AEK	AKS	ARG	AWV	BLR
AAC	AEY	AKT	ARM	AWX	BLY
AAE	AFF	AKU	ARX	AXA	BMB
AAZ	AFN	AKW	ARY	AXX	BPJ
ABF	AFT	ALE	ARZ	AYD	BPY
ABK	AGD	ALH	ASV	AYP	BSE
ABL	AGG	ALZ	ASX	AYQ	BSF
ABM	AGN	AMK	ASY	AZH	BWA
ABS	AGP	ANA	ATM	AZJ	CS
ABT	AGR	ANB	ATU	AZL	CY
ACE	AGU	APF	AUM	AZM	DE
ACV	AHB	APG	AUQ	BAM	MD
ADA	AHF	APK	AUR	BEH	ME
ADL	AHG	APP	AVC	BFQ	MF
ADP	AHH	APT	AVG.1V	BFS	1F
ADR	AHL	APU	AVU	BGB	1Y
ADY	AHU	APX	AWC	BGU	1Z
ADZ	AJH	APY	AWF	BHD	2E
AEB	AJL	AQA	AWG	BJJ	
AEF	AJP	AQM	AWP	BJK	
AEG	AJQ	AQX	AWT	BJL	
AEH	AKL	AQY	AWU	BJM	

## 53281

1.30 - 5 -

KIT DI ATTREZZI DI ALLINEAMENTO ALBERO A CAMME VW/AUDI



### MODELLO

2,5 TDI V6

### UTENSILI OEM

T20102
T30052
T30092
T30094
T40011
T40237
3078
3242
3359
3369
3458

### CODICE MOTORE

AFB
AKE
AKN
AYM
BAU
BCZ
BDG
BDH
BFC

## 53279

2.10 - 5 135

KIT DI ATTREZZI DI REGOLAZIONE CINGHIA DENTATA PER VW/AUDI 1.8, 2.0, TSI, TFSI



### MODELLO

AUDI: A3 1996-2009, A4 1994-2009, A6 1995-2011, S3 1999-2013, TT 1998-2014  
SEAT: ALHAMBRA 1997-2010, ALTEA/ALTEA XL 2006-2009, CORDOBA 1999-2002, EXEO 2009-2010, IBIZA 1999-2002, LEON 1999-2013, TOLEDO 1999-2009  
SKODA: OCTAVIA/OCTAVIA TOUR 1998-2010, OCTAVIA II 2004-2009  
VW: BEETLE 1999-2011, BORA 1997-2004, EOS 2006-2010, GOLF 1997-2012, GOLF PLUS 2005-2009, JETTA 2005-2009, PASSAT 2996-2010, SCIROCCO 2009-2014, SHARAN 1997-2010, TOURAN 2003-2009

### UTENSILI OEM

T10020	T10115	T20167	3204
T10060	T10252	T40011	3366
T10060A	T20018	T40098	
T10092	T20044	V 159	

### CODICE MOTORE

AWA	BPG	BWT	CDLJ
AXW	BPJ	BYD	CDLK
AXX	BPY	BYK	CDMA
BGB	BUL	BZC	
BHD	BVX	CDLA	
BHZ	BVY	CDLB	
BLR	BVZ	CDLC	
BLX	BWA	CDLD	
BLY	BWE	CDLF	
BMB	BWJ	CDLG	

**53282**
 1.75
  -
  5
  165

KIT TRAFORO GRUPPO VAG 1.2, 1.4, 1.6

**MODELLO**

VAG 1.2, 1.4, 1.6

**UTENSILI OEM**

T10170

T10171

T10171A

T10340

T10414

T40011

**CODICE MOTORE**

AXU CAVE CTHA

BAG CAVF CTHB

BKG CAVG CTHC

BLF CAXA CTHD

BLG CAXC CTHE

BLN CBZA CTHF

BLP CBZB CTHG

BMY CBZC CTJB

BTS CDGA CTJC

BWK CKMA CTKA

CAVA CLRA

CAVB CMSA

CAVC CMSB

CAVD CNVA

**53283**
 2.10
  -
  5
  150

KIT DI SPESSORI GRUPPO VAG 2.7, 3.0 TDI

**MODELLO**

VAG 2.7, 3.0 TDI

**UTENSILI OEM**

MP 1 301

T40062

T20102

T40237

T30052

U40074

T40049

VM 9882

T40058

3242

T40060

3359

T40061

9882

**CODICE MOTORE**

ASB CANB CDVC

BKN CANC CDYA

BKS CAND CEXA

BMK CAPA CGKA

BMZ CARA CGKB

BNG CARS CRT

BPP CASA CRTC

BSG CASC CRTD

BUG CASE CRTE

BUN CAWA CRTF

BWZ CCHA

CAM CCWA

CAMB CCWB

CANA CDVB

**53284**
 8.90
  -
  2
  48

KIT TRAFORO GRUPPO VAG 2.5 TDI

**MODELLO**

VAG 2.5 TDI

**UTENSILI OEM**

T10193

T10194

T10199

T10199/01

T10225

T10226

T10234

**CODICE MOTORE**

AXD

AXE

AYH

BAC

BLE

BLJ

BLK

BNZ

BPC

BPD

BWF

FMB

**53285**
 1.95
  -
  5
  135

KIT DI ATTREZZI DI REGOLAZIONE CINGHIA DENTATA PER VAG 2.4, 2.5, SDI, TDI

**MODELLO**

VAG 2.4, 2.5 SDI, TDI

**UTENSILI OEM**

MP 1 300

T10025

U40021

2065A

21 105

3355

3419

5190

999 5190

999 5649

**CODICE MOTORE**

ACV

AGX

AHD

AHY

AJT

ANJ

APA

AUF

AVR

AXG

AXL

AYC

AYY

BBE

BBF

D5252T



## 53286

3.00 - 5 150

KIT DI ATTREZZI DI REGOLAZIONE CINGHIA DENTATA PER VAG VAG 1.8, 2.0 TSI, TFSI



### MODELLO

VOLKSWAGEN 1.8, 2.0TSI / TFSI

### UTENSILI OEM

T10060A	T10354	T40196
T10352	T10368	T40267
T10352/1	T40011	T40271
T10352/2	T40098	

### CODICE MOTORE

BYT	CBFA	CDNC
BZB	CCTA	CDND
CABA	CCZA	CESA
CABB	CCZB	CETA
CABD	CCZC	CFKA
CADA	CDAA	CGYA
CAEA	CDAB	CJBA
CAEB	CDHA	CJEB
CAWA	CDHB	CJSB
CAWB	CDNB	

## 53287

4.60 - 2 40

KIT DI ATTREZZI DI REGOLAZIONE CINGHIA DENTATA PER VW/AUDI 1.8, 2.0L TURBO

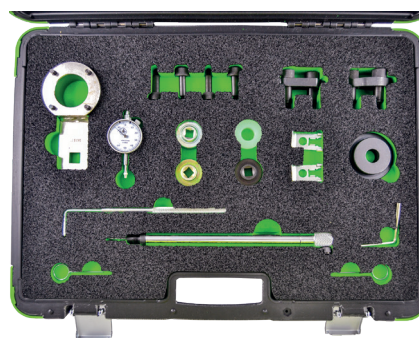

### MODELLO

1.8, 2.0 TSI, TFSI

### UTENSILI OEM

T10060A	T10354	T40196
T10352	T10368	T40267
T10352/1	T40011	T40271
T10352/2	T40098	

### CODICE MOTORE

BYT	CCTA	CESA
BZB	CCZA	CETA
CABB	CCZB	CFKA
CABD	CCZC	CGYA
CADA	CDAA	CJEB
CAEA	CDAB	CJSA
CAEB	CDHB	CJSB
CAWA	CDNB	
CAWB	CDNC	
CBFA	CDND	

## 53288

2.05 - 5 140

KIT DI ATTREZZI DI REGOLAZIONE CINGHIA DENTATA PER VAG 1.6, 2.0 TDI COMMON RAIL



### MODELLO

VAG 1.6, 2.0 TDI

### UTENSILI OEM

MB995206	T10052	U40074	3359
MB995231	T10100	VM 9882	9882
MP 1 301	T10264	VM 9883	
T100255	T10265	10122	
T10050	T20102	23 059	
T10051	T40098	310 085	

### CODICE MOTORE

CAAA	CBDA	CFHE	CLCB
CAAB	CBDB	CFHF	CLJA
CAAC	CBDC	CFJA	CLLA
CAAD	CCHA	CFJB	CLLB
CAAE	CCHB	CFWA	CLNA
CAGA	CDBA	CGLA	CMEA
CAGB	CDCA	CGLB	CMFA
CAGC	CEGA	CGLC	CMFB
CAHA	CFCA	CGLD	CMGB
CAHB	CFFA	CGLE	CNEA
CAYA	CFFB	CJAA	CNFA
CAYB	CFFD	CJCA	CNFB
CAYC	CFFE	CJCB	CSHA
CAYD	CFGB	CJCC	CSLB
CAYE	CFGC	CJCD	CSNA
CBAA	CFGD	CKTB	
CBAB	CFHA	CKTC	
CBAC	CFHB	CKUB	
CBBA	CFHC	CKUC	
CBBB	CFHD	CLCA	

## 53648

3.70 - 2 48

KIT DI ATTREZZI PER LA MESSA IN FASE DELLA DISTRIBUZIONE PER VAG 1.0, 1.2, 1.4 TSI



### MODELLO

AUDI: A1 (12-15), A1 SPORTBACK (12-15), A3 (13-15), A3 SPORTBACK (12-15)  
SEAT: IBIZA (12-15), LEON (12-15), TOLEDO (12-15)  
SKODA: FABIA (10-13), OCTAVIA II (10-13), OCTAVIA III (10-15)

### UTENSILI OEM

T10060A	T10499
T10340	T10501/1
T10476	T10504
T10477	T10504/2
T10487	
T10494	

### CODICE MOTORE

CHPA	CVNA
CHPB	CWVA
CHYE	CWVB
CHZJ	CXSA
CHZL	CXSB
CJZA	CYVA
CJZB	CYVB
CJZC	CYVD
CJZD	CZCA
CMBA	CZCC
CPGA	CZDA
CPTA	CZDB
CPVA	CZEA
CPVB	DAFA
CPWA	DJKA
CRJA	
CUKB	
CUKC	

## 53326

0.30 10 40 -

ATTREZZO DI REGOLAZIONE  
CINGHIA DENTATA PER VW/AUDI



## MODELLO

AUDI: A4/ A4 QUATTRO 1997-2008, A4 CABRIO 2003-2009, A6/ A6 QUATTRO 1997-2005, A6 ALLROAD 2000-2005, A8 1997-2002  
SKODA: SUPERB 2002-2008

## UTENSILI OEM

3242  
3458

## CODICE MOTORE

AFB  
AKE  
AKN  
AYM  
BAU  
BCZ  
BDG  
BDH  
BFC

## 53327

0.20 10 60 3600

ATTREZZO DI REGOLAZIONE  
CINGHIA DENTATA PER VAG 1.2



## MODELLO

SEAT: IBIZA 1.2 6V/3CYL (2002-09), CORDOBA 1.2 12V/3CYL (2002-13)  
SKODA: FABIA 1.2 6V-12V/3CYL (2002, 2003-), FABIA II 1.2 6V/3CYL (2007-13), ROOMSTER 1.2 12V/3CYL (2006-13), PRAKTIK 1.2 6V/3CYL (2007-13)  
VW: POLO 1.2 6V-12V/3CYL (2002-14)

## UTENSILI OEM

T10123

## CODICE MOTORE

AWY  
AZQ  
BBM  
BMD  
BME  
BXV  
BZG  
CEVA  
CGPA  
CGPB  
CGPC  
CHFA  
CHFB

## 53320

0.15 10 40 -

SET UTENSILI PER FASATURA VAG



## MODELLO

AUDI: A2 2001-2006, A3 2001-2002, A4/QUATTRO 1999-2002, A6/QUATTRO 1998-2002  
SEAT: ALHAMBRA 1999-2010, AROSA 1999-2005, LEON 2000-2005, TOLEDO 2000-2005  
SKODA: FABIA 2000-2005, OCTAVIA/OCTAVIA TOUR 2000-2006, SUPERB 2002-2002  
VOLKSWAGEN: BEETLE 2000-2011, BORA 1998-2002, GOLFIV 1998-2002, LUPO 1999-2005, PASSAT 1998-2002, POLO 1999-2002, SHARAN 1999-2002

## UTENSILI OEM

T10008  
T10100  
T20102

## CODICE MOTORE

AJM	AVB
AMF	AVF
ANU	AWX
ANY	AXR
ARL	AYZ
ASZ	BHC
ATD	BSW
ATJ	BTB
ATL	BVK
AUY	

## 53649

3.48 - 2 48

SET DI STRUMENTI PER LA FASATURA DEL MOTORE VAG GROUP



## MODELLO

AUDI  
SEAT  
SKODA  
VW

## UTENSILI OEM

T10340  
T10476  
T10477  
T10487  
T10494  
T10499

## CODICE MOTORE

CHPA	CJZD
CHYA	CMBA
CHYB	CPTA
CHZA	CVNA
CHZB	CYVA
CHZC	CYVB
CHZD	CZCA
CHZE	CZCC
CHZJ	CZDA
CJZA	CZEA
CJZB	
CJZC	

### 53325

0.10 20 100 -

CHIAVE PULEGGIA TENDITORE PER VW AUDI



#### MODELLO

AUDI: A6 1994-1997  
VOLKSWAGEN: TRANSPORTER T4 1995-2003, LT 1996-2006, CRAFTER 2006-2013  
VOLVO: 850 1996-1997, S70 1997-2000, S80 1998-2001, V70 1997-2001

#### UTENSILI OEM

3355  
999 5649

#### CODICE MOTORE

AAB	AVT
AAT	AXG
ACU	AXL
ACV	AYC
AEL	AYY
AET	BBE
AGX	BBF
AHD	BJJ
AHY	BJK
AJA	BJL
AJT	BJM
ANJ	CEBA
APA	CEBB
APL	CECA
AUF	CECB
AVR	D5252T

### 53321

0.25 10 50 -

CHIAVE REGOLAZIONE TENSIONAMENTO CINGHIA PER VW AUDI



#### MODELLO

AUDI: A4/1.8T,2.0 1999-2004 A6/1.8T 2002-2004 A4/3.0 (2002 - ), A6/3.0 (2002 - ), A8/7.0 (2003 - ).  
VW: GOLF PASSAT 2.0 TDI DIESEL, GOLF 88-97, PASSAT 92-97, VW T4/2.0 1992-2004

#### UTENSILI OEM

T10020

### 54092

0.80 5 10 240

KIT DI CONTROLLO E REGOLAZIONE DI FASI DISTRIBUZIONE DEL GAS PER IL MOTORE VAG 1.2 TFSI



#### MODELLO

AUDI: A1, A1 SPORTBACK, A3, A3 CABRIOLET, A3 LIMOUSINE, A3 SPORTBACK, TT, TT ROADSTER  
SEAT: IBIZA, IBIZA V SPORTCOUPE, IBIZA V ST, LEON, LEON SC, LEON ST, TOLEDO IV  
SKODA: FABIA, FABIA KOMBI, OCTAVIA, OCTAVIA COMBI, RAPID, RAPID SPACEBACK  
VOLKSWAGEN: GOLF ALLTRACK, GOLF SPORTSVAN, GOLF VII, GOLF VII KOMBI, PASSAT, POLO

#### UTENSILI OEM

T10340  
T10341  
T10414

#### CODICE MOTORE

CBZA  
CBZB  
CBZC

### 54408

1.85 5 135

SET DI STRUMENTI PER LA FASATURA DEL MOTORE VAG DIESEL 1.7, 1.9, SDI, TDI



#### MODELLO

AUDI  
SEAT  
SKODA  
VW

#### UTENSILI OEM

T10020  
T10092  
T10098  
T20044  
T20038  
T20102  
T40011  
1302  
2064  
2065A  
3359

#### CODICE MOTORE

AAC	AEG	AJH	APT	ASY	AYP	BPJ
AAE	AEY	AJL	APU	ATM	AYQ	BPY
AAZ	AFF	AJP	APX	ATU	AZG	BSX
ABF	AFN	AJQ	APY	AUM	AZH	BVP
ABK	AFY	AKT	AQA	AUQ	AZJ	BVR
ABL	AGD	AKU	AQE	AVC	AZL	BWA
ABS	AGG	AKW	AQM	AVG	AZM	DV
ACE	AGN	ALE	AQX	AVV	BAM	DW
ACL	AGP	ALH	AQY	AWC	BBX	KY
ACT	AGR	AMK	ARG	AWF	BEH	1G
ADL	AGU	AMU	ARH	AWG	BFV	1S
ADR	AHB	ANB	ARX	AWT	BGB	1X
ADY	AHF	APG	ARY	AWU	BHD	1Y
ADZ	AHG	APJ	ARZ	AXA	BLR	1Z
AEB	AHH	APK	ASV	AXW	BLY	2E
AEF	AHU	APP	ASX	AXX	BMB	

## 53706

 1.95  -  5  150

## KIT DI ATTREZZI DI FASATURA VAG 1.4, 1.6, 2.0 TDI COMMON RAIL



## MODELLO

AUDI: A1/A1 SPORTBACK (8XF/8XK) 2015-2018, A3/SPORTSBACK/CABRIO (8VA/8V1/8V7/8VS) 2012-2016, A3/SPORTSBACK/CABRIO (8VK/8VF/8VE/8VM) 2016-2020, A4 (8K2/8K5/8KH) 2013-2016, A4(8W2/8W5/8WH/8WC/8WD/8WJ) 2015-ON, A5 I (8F7/8T3/8TA) 2013-2017, A5 II (F57/F53/F5) 2017-ON, SEAT: ALHAMBRA (711) 2015-ON, ARONA (KJ7) 2017-ON, ATECA (KH7) 2016-2020, IBIZA (6P) 2015-2017, IBIZA (KJ1) 2017-ON, LEON (5F1/5F5) 2012-2020, LEON ST (5F8) 2013-2020, TARRACO (KN2) 2019-ON, TOLEDO (KG3) 2015-2019

SKODA: FABIA III (NJ) 2014-2018, KAMIQ (NW4) 2019-ON, KAROQ (NU7) 2017-ON, KODIAQ (NS7/NV7) 2017-ON, OCTAVIA III (5E3/SE5) 2013-2020, RAPID/SPACEBACK (NH3/NH1) 2015-2018, SCALA (NW1) 2019-ON, SUPERB III (3V3/3V5) 2015-ON, YETI/OUTDOOR (5L6/5L7) 2013-2017

VOLKSWAGEN: AMAROK (2HX/S1B) 2010-2016, ARTEON (3H7) 2017-2020, BEETLE (5C1,5C2,5C7,5C8) 2011-2018, CADDY/CADDY MAXI (SAX) 2015-2021, CC (358) 2015-2017, CRAFTER (SY/SZ) 2017-ON, GOLFSV CABRIO (517) (11-16) 2015-2016, GOLF SV/SPORTSVAN (AM1,AN1) 2014-ON, G

## UTENSILI OEM

EN-52137	T20167	3204
MOT 1430	T40098	3359
T10051	0132AJ1	49 JE02 021
T10060	0187B	607589011500
T10060A	0189B	999 7122
T10264	0194B	
T10265	0991958120	
T10409	21 263	
T10490	303 735	
T10492	3031277	

## CODICE MOTORE

CDBA	CNHC	CRVA	CUJA
CDCA	CRBC	CRVC	CUUA
CGLE	CRBD	CSHA	CUUB
CKFB	CRFA	CSUA	CUUC
CKFC	CRFC	CSUB	CUUD
CLHA	CRKA	CSUD	CUUE
CLHB	CRKB	CSUE	CUUF
CLHC	CRLB	CUAA	CUVA
CNEA	CRLC	CUNA	CUVB
CNFA	CRLD	CUPA	CUVC
CNFB	CRMB	CUSA	CUVD
CNHA	CRUA	CUSB	CUVE

CUWA	DBGC	DFBA	DGDB
CXEB	DBKA	DFCA	DGTA
CXEC	DCXA	DFEA	DGTC
CXFA	DCYA	DFEB	DGTD
CXGA	DCYB	DFFA	DGTE
CXGB	DCZA	DFGA	DJGA
CXHA	DDAA	DFGB	DLTA
CXHB	DDCA	DFGC	DLTC
CXMA	DDCB	DFHA	DLUB
CXXA	DDDA	DFLA	DTRD
CXXB	DDYA	DFLD	DTTA
CYKA	DDYB	DFMA	DTTC
CYKB	DEJA	DFSA	
CYKC	DEJB	DFSB	
CZJA	DESA	DFSC	
DASA	DETA	DFSD	
DASB	DETB	DFSE	
DAUA	DEUA	DFSF	
DAUB	DEUB	DFTA	
DAVA	DEUC	DFTB	
DAWA	DEZB	DFTC	
DAWB	DEZD	DFUA	
DBGA	DEZE	DGCA	
DBGB	DEZF	DGDA	

## 54409

 1.33  5  10  240

## KIT DI MESSA IN FASE PER VAG 1.4 TSI



## MODELLO

AUDI: A1/A1 SPORTBACK (8XA/8X1)(8XF/8XK) 2012-2018, A3 (8V) 2012-ON, Q2 (GAB) 2016-ON, Q3 (8UG) 2015-2018

SEAT: ATECA (KH7) 2016-ON, IBIZA (6J/6P) 2013-2017, LEON/LEON ST (5F) 2012-2020

SKODA: KODIAQ (NS7) 2017-ON, SUPERB (3V3/3V5) 2015-ON

VOLKSWAGEN: GOLF VII (5G1) 2012-2017, PASSAT (3G2/3G5) 2014-ON, POLO MK5 (6C1)(6R1) 2012-2018

## UTENSILI OEM

T10340  
T10504  
T10504/1  
T10504/2

## CODICE MOTORE

CPTA  
CZEA

## 54410

1.50 5 10 240

KIT DI MESSA IN FASE PER VAG 2.4, 3.2 FSI



### MODELLO

AUDI: A4, A5, A6, A7, A8, Q5, Q7, R8, RS4, RS5, RS6, S4, S5, S6, S8  
VOLKSWAGEN: TOUAREG (2010-2014)

### UTENSILI OEM

T40058	T40133/1
T40069	T40133/1/2
T40071	T40133/2
T40133	40071

### CODICE MOTORE

AUK	BXA
BAR	BYH
BDW	CAUA
BKH	CDRA
BNS	CFSA
BPK	CMPA
BSM	CNDA
BUH	CTPA
BUJ	CTYA
BUJ	

## 54411

1.58 5 10 240

KIT DI MESSA IN FASE PER VAG/ PORSCHE 2.4, 2.8, 3.0 TFSI



### MODELLO

AUDI: A4 (2011-2015), A5 (2007-2017), A6 (2007-2018) A7 (2010-2018) A8 (2010-2018) A8 (2010-2018) G7 (2010-2018) S4 (2009-2017) S5 (2010-2017) S5 (2010-2017) Q5 (2008-2017) SQ5 (2013-2018)  
PORSCHE: CAYENNE 2010-2014, PANAMERA 2011-2013  
VAG: TOUAREG 2010-2014

### UTENSILI OEM

T40058	T40133/1
T40069	T40133/1/2
T40071	T40133/2
T40133	40071

### CODICE MOTORE

BDX	CGXB	CNYA
CAJA	CGXC	CPAA
CAKA	CHMA	CREA
CALA	CHMB	CREC
CALB	CHVA	CRED
CCAA	CJBA	CTTA
CCDA	CJTA	CTUA
CCEA	CJTB	CTUD
CGEA	CJTC	CTVA
CGFA	CJWC	CTWA
CGWA	CLXB	CTWB
CGWB	CMDA	CTXA
CGWC	CMUA	M06/EC
CGWD	CNA	

## 54412

2.19 - 5 240

KIT DI MESSA IN FASE PER AUDI 2.5 TFSI



### MODELLO

AUDI TT (2016 - 2018), Q3 & Q3 RS (2019-), RS3 SALOON, (2016 - 2018) & RS3 SPORTBACK (2016 - 2018)

### UTENSILI OEM

T03003
T40011
T40069
T40264 12
T40264 2A
T40297

### CODICE MOTORE

CEPA
CEPB
CTSA
CZGA
CZGB

## 54413

2.68 - 5 135

KIT DI MESSA IN FASE PER AUDI 4.0 FSI, TFSI



### MODELLO

AUDI: A8, RS6, RS7, S6, S7, S8 (2012-2018)

### UTENSILI OEM

T40071
T40257
T40264/1
T40264/2
T40264/3
T40269
T40272

### CODICE MOTORE

CEUA
CEUC
CGTA
CRDB
CTFA
CTGA
CTGE
CWUB
CWUC
DDTA

## 54431

2.50 - 5 135

KIT DI MESSA IN FASE PER ALFA ROMEO/MASERATI 2.9



## MODELLO

ALFA ROMEO: GIULIA, STELVIO  
MASERATI: 3,8T

## UTENSILI OEM

1860815000  
2024000090  
2024100000

## CODICE MOTORE

670050436  
670051007  
670052721  
670052722

## 53315

7.15 - 2 42

KIT DI ATTREZZI DI REGOLAZIONE CINGHIA DENTATA PER VOLVO 3.0, 3.2T6 / LAND ROVER 3.2



## MODELLO

LAND ROVER FREELANDER II (11-14)  
VOLVO S60 (10-16), S80 (07-15), XC60 (08-15), XC70 (06-15), XC 90 (10-14), V60 (10-15), V70 (10-15)

## UTENSILI OEM

303-1219  
303-1225  
303-1226  
303-1233  
999-7257  
999-7261  
999-7263  
999-7264  
999-7272

## CODICE MOTORE

B6304T2  
B6304T4  
B6324S  
B6324S5

## 54226

2.10 - 5 120

SET ESTRATTORE PER PULEGGIA POMPA AD ALTA PRESSIONE PER HYUNDAI/KIA



## MODELLO

HYUNDAI: ACCENT (11-15), ELANTRA (07-10), I20 (09-18), IX20 (10-18), I20 COUPE (15-17), I30 (07-19), IX35 (10-16), I40 (11-18)

KIA: CARENS (13-18), CEED (07-18), OPTIMA (11-15), PRO-CEED (08-19), RIO (09-17), CERATO (05-07), SOUL (09-14), SPORTAGE (10-18), VENGA (09-18)

## UTENSILI OEM

09331-2A000  
09331-2A010

## CODICE MOTORE

D3FF  
D4FB-H(U1)  
D4FB-H(U2)  
D4FB-L(U1)  
D4FB(U1)  
D4FB(U2)  
D4FC(U1)  
D4FC(U2)  
D4FD-H(U2)  
D4FD-L  
D4FD-L(U2)  
D4FD(U2)

## 54200

1.15 - 5 10 240

KIT DI ATTREZZI DI CRONOMETRAGGIO DEL MOTORE PER PORSCHE



## MODELLO

911 (01-08), BOXTER (02-11), CAYMAN (06-09)

## UTENSILI OEM

9595  
9595/1  
9685  
9686

## CODICE MOTORE

M96/03  
M96/05  
M96/23  
M96/24  
M96/24S  
M96/25  
M96/26  
M97/01  
M97/01S  
M97/20  
M97/21  
M97/22

### 54199

2.10 - 5 165

KIT DI ATTREZZI DI CRONOMETRAGGIO DEL MOTORE PER VAG TFSI, FSI



#### MODELLO

AUDI: A1 (10-15), A1 SPORTBACK (10-15), A3 CABRIOLET (10-13), A3 (10-15), A3 SPORTBACK (03-13)

SEAT: ALTEA/ALTEA XL (10-15), IBIZA (10-15), LEON (10-13), TOLEDO (12-15)

SKODA: FABIA II (10-15), PRAKTIK (10-15), RAPID (12-15), RAPID SPORTBACK (12-15), OCTAVIA II (04-13), YETI (09-15), YETI OUTDOOR (13-15)

TIGUAN (07-15), TOURAN (03-15)

VW: BEETLE (11-15), CADDY/CADDY MAXI (10-15), EOS (07-15), GOLF V (03-13), GOLF V ESTATE (07-09), GOLF VI (10-13), GOLF VI ESTATE (10-13), GOLF VI CABRIOLET (11-15), GOLF PLUS (05-14), JETTA (05-14), PASSAT (05-15), POLO (09-14), SCIROCCO (08-14)

#### UTENSILI OEM

T10170	T10414
T10171/	T40011
T10171A	VAS6079
T10340	

#### CODICE MOTORE

BAG	CAVE
BLF	CAVF
BLG	CAXA
BLP	CAXC
BMV	CBZA
BWK	CBZB
CAVA	CBZC
CAVB	CDGA
CAVC	CSMA
CAVD	

### 54218

1.95 - 5 135

KIT DI ATTREZZI DI MONTAGGIO PER AMMORTIZZATORE DI VIBRAZIONI VAG

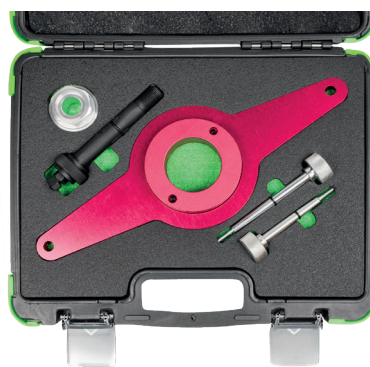

#### MODELLO

AUDI  
SEAT  
SKODA  
VOLKSWAGEN

#### UTENSILI OEM

T10531/1
T10531/2
T10531/3
T10531/4

#### CODICE MOTORE

BPU	CHJA	CYGA
BYT	CJEB	CYNB
BZB	CJED	CYPA
CABA	CJEE	CYPB
CABB	CJSA	CYRB
CABD	CJSB	CYRC
CAWB	CJXA	CZPB
CBFA	CJXB	DAJB
CCTA	CJXC	DAXB
CCZA	CJXD	DEMA
CCZB	CJXE	DJHA
CCZC	CJXF	DJHB
CDAA	CJXG	DKYA
CDHA	CNCB	DKZA
CDHB	CNCD	DKZB
CDNB	CNCE	DKZC
CDNC	CPSA	DLVA
CESA	CULB	DLVB
CETA	CULC	
CFKA	CVKB	
CHHB	CVLA	
CHHC	CWZA	

### 54407

12.50 - 1 26

KIT ATTREZZI PER MONTAGGIO ALBERO A CAMME PER VAG/PORSCHE

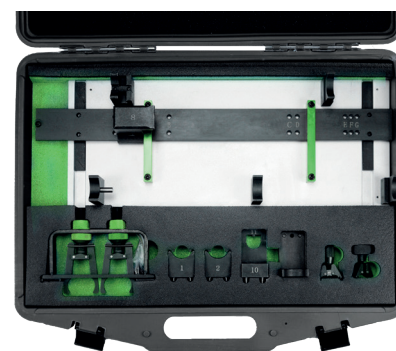

#### MODELLO

AUDI  
PORSCHE  
SEAT  
SKODA  
VW

#### UTENSILI OEM

T40094	T40094/2
T40094/1	T40094/9
T40094/10	T40095
T40094/11	T40096/1

#### CODICE MOTORE

VSE5951, VSE5952, VSE6181  
CFWA  
CAYA, CAYB, CAYC, CAYD, CAYE, CEGA, CLNA, CRKB  
CAYA, CAYB, CAYC, CAYD, CAYE, CEGA, CLNA, CRKB  
CDCA, CKTB  
CBAB, CFGB  
CAAA, CAAB, CAAC, CAAD, CAAE, CAGA, CAGB, CAGC,  
CAHA, CAHB, CAYB, CBAA, CBAB, CBAC, CBBA, CBBB,  
CBDA, CBDB, CBDC, CCHA, CCHB, CDBA, CFCA, CEGA,  
CFFA, CFFB, CFFE, CFGB, CFGC, CFGD, CFHA, CFHB, CFHC,  
CFHD  
CFHE, CFHF, CFJA, CGLA, CGLB, CGLC, CGLD, CJAA, CJC  
BPP, CANC, CAMA, CANA, CGKA  
ASB, BNG, CASA, CASB, CASD, CAPA, CARA, CASD, CCMA,  
CCWA, CCWB, CDUC, CDYA, CDYB, CDYC, CDTA, CDTB,  
CDUD, CEXA, CJMA, CJGD, CJMA, CRCA, CLAA, CLAB,  
CMHA, CRCA, MCT.BA, CTB, MCR.CC, M059D, M059E  
ASE  
CCFA, CCFC, CDSB, MCU.DB

### 51340

2.15 - 6 180

CHIAVE UNIVERSALE PER ALBERO A CAMME + ADATTATORI



### 51927

0.65 - 5 640

KIT DI SMONTAGGIO E MESSA IN TENSIONE DI CINGHIE POLY-V



### 52616

0.35 - 10 40 800

TENSIOMETRO PER CINGHIA DI DISTRIBUZIONE

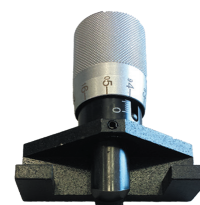

53769

 5.90  -  2  32

## MODULO DI REGOLAZIONE CINGHIA DENTATA PER RENAULT/NISSAN/OPEL/VOLVO

## MODELLO

DACIA DOKKER, DUSTER, LOGAN, SANDERO  
 NISSAN ALMERA, INTERSTAR, KUBISTAR, MICRA, NOTE, PRIMERA, QASHQAI  
 OPEL/VAUXHALL MOVANO, VIVARO  
 RENAULT AVANTIME, CLIO, ESPACE, KANGOO, LAGUNA, MASTER, MEGANE, MODUS, SCENIC,  
 TWINGO, TRAFFIC  
 VOLVO S40, V40

## UTENSILI OEM

B0280	KM-6205	KV113 B0360	MOT 1312
KM-6031	KM-6234	MOT 1054	MOT 1318
KM-6203	KV113	MOT 1135-01	MOT 1337
KM-6204	KV113 B0130	MOT 1200-01	

## CODICE MOTORE

D4F701	E7J624	E7J780	F3R729	F8Q640	F8Q788	F9Q759	G8T760	J7R	K4J714	K4M736	K4M801	K9K762	S9U704
D4F702	E7J626	F1N	F3R750	F8Q644	F9Q610	F9Q760	G8T790	J7R732	K4J715	K4M740	K4M802	K9K764	S9U714
D4F706	E7J634	F2N	F3R751	F8Q646	F9Q650	F9Q762	G8T792	J7R733	K4J730	K4M742	K4M804	K9K766	S9U740
D4F708	E7J635	F2R	F3R752	F8Q648	F9Q664	F9Q768	G8T794	J7R734	K4J732	K4M743	K4M812	K9K768	S9W206
D4F710	E7J680	F3N	F3R791	F8Q662	F9Q670	F9Q770	G9T600	J7R735	K4J740	K4M744	K4M813	K9K802	S9W208
D4F712	E7J700	F3P	F3R796	F8Q672	F9Q674	F9Q772	G9T605	J7R768	K4J750	K4M745	K4M830	K9K804	S9W212
D4F714	E7J706	F3P670	F3R797	F8Q678	F9Q715	F9Q774	G9T700	J7T600	K4J770	K4M746	K7M	K9K806	S9W700
D4F716	E7J710	F3P682	F3R798	F8Q680	F9Q716	F9Q780	G9T702	J7T760	K4J780	K4M748	K9K700	N7Q704	S9W702
D4F720	E7J711	F3P700	F4P	F8Q682	F9Q717	F9Q782	G9T703	J7T761	K4M700	K4M750	K9K702	N7Q710	
D4F722	E7J716	F3P704	F4R	F8Q684	F9Q718	F9Q784	G9T706	J7T762	K4M701	K4M752	K9K704	N7Q711	
D4F726	E7J718	F3P706	F5R700	F8Q692	F9Q720	F9Q786	G9T707	J7T766	K4M704	K4M753	K9K706	N7U700	
D4F728	E7J719	F3P708	F5R701	F8Q696	F9Q722	F9Q788	G9T710	J7T772	K4M706	K4M754	K9K710	N7U701	
D4F730	E7J720	F3P710	F5R740	F8Q706	F9Q730	F9Q790	G9T712	J7T780	K4M707	K4M760	K9K712	S8U720	
D4F740	E7J724	F3P712	F7P704	F8Q714	F9Q731	F9Q796	G9T720	J7T782	K4M708	K4M761	K9K714	S8U722	
D4F744	E7J726	F3P714	F7R710	F8Q720	F9Q732	F9Q800	G9T722	J8S620	K4M709	K4M762	K9K716	S8U730	
D4F746	E7J728	F3P720	F7R714	F8Q722	F9Q733	F9Q803	G9T742	J8S621	K4M710	K4M764	K9K718	S8U731	
D4F764	E7J740	F3P722	F8M736	F8Q730	F9Q734	F9Q804	G9T743	J8S622	K4M711	K4M765	K9K722	S8U742	
D4F766	E7J742	F3P724	F8M760	F8Q732	F9Q736	F9Q808	G9T750	J8S758	K4M712	K4M766	K9K724	S8U748	
D7F700	E7J745	F3P755	F8Q600	F8Q740	F9Q738	F9Q812	G9U720	J8S760	K4M714	K4M768	K9K728	S8U750	
E5F	E7J754	F3P758	F8Q606	F8Q742	F9Q740	F9Q816	G9U724	J8S776	K4M716	K4M776	K9K729	S8U752	
E6J	E7J756	F3P760	F8Q610	F8Q744	F9Q744	F9Q818	G9U726	J8S778	K4M718	K4M782	K9K732	S8U770	
E7F700	E7J757	F3R	F8Q620	F8Q764	F9Q748	F9Q820	G9U730	K4J700	K4M720	K4M788	K9K734	S8U772	
E7F704	E7J764	F3R611	F8Q622	F8Q768	F9Q750	G8T714	G9U750	K4J710	K4M724	K4M790	K9K740	S8U780	
E7F706	E7J770	F3R722	F8Q624	F8Q776	F9Q752	G8T716	G9U754	K4J711	K4M730	K4M791	K9K750	S8U782	
E7F750	E7J771	F3R723	F8Q630	F8Q784	F9Q754	G8T740	J5T	K4J712	K4M732	K4M794	K9K752	S9U700	
E7J601	E7J773	F3R728	F8Q632	F8Q786	F9Q758	G8T752	J6R	K4J713	K4M734	K4M800	K9K760	S9U702	



53771

 4.05  -  3  36

## MODULO DI REGOLAZIONE CINGHIA DENTATA PER FIAT/FORD/CITROËN/PEUGEOT

## MODELLO

CITROËN: C15, C1, C2, C3 PLURIEL, C4, C4 PICASSO, C5, C6, C8, DS3, DS4, DS5, XANTIA, XSARA, XSARA  
 PICASSO, EVASION, BERLINGO, JUMPY, JUMPER, SAXO, ZX, XM, EVASION, AX  
 FIAT: ULYSSE, SCUDO, DUCATO  
 FORD: FIESTA, FUSION, FOCUS, FOCUS C-MAX  
 LANCIA: ZETA, PHEDRA  
 PEUGEOT: 107, 1007, 206 CC, 207, 208, 306, 307 CC, 308, 406, 407, 508, 607, 806, 607, 806, 807, PARTNER,  
 EXPERT, BOXER, 206, 106, 605, 205, 405

## UTENSILI OEM

MOT 1436	0153-M	0188-J1	0189-L	21-262	7014-TM
0117-AR	0153-N	0188-J2	0189-R	303-734	7015-T
0132-AB	0153-U	0188-M	0189-S1	4200-TH	7017-TM
0132-AJ1	0153-4	0188-P	0189-S2	4507-TJ	7017-TR
0132-AK	0178-C	0188-Q1	0194-A	4507-TL	7019-T
0132-P	0178-D	0188-Q2	0194-B	4527-TS1	7099-TM
0132-X	0178-E	0188-X	0194-C	4527-TS2	9004-T
0134-AF	0188-AH	0188-Y	0606-A1A2	4533-TAC1	9041-TZ
0134-Q	0188-AK	0189-A	174	4533-TAD	9765-54
0153-AB	0188-D	0189-C	188-P2	5711TA	9767-89
0153-AK	0188-E	0189-J	189-B	6012-T	9767-94
0153-G	0188-F	0189-K	21-163	7014-TJ	9797-34

## CODICE MOTORE

DV4TED4	EW10A	EW7 J4 (RLZ)	HHDA	TU3 (KDX/KDY/KDZ/KFX/KFZ)	XU7 JP4
DV6ATED4	EW10-CVI	EW7J4	HHDB	TU3A/JP	XU7 (LFW/LFX/LFZ)
DW10	EW10D	F6JA	HHJA	TU5JP4 (NFU/NFX)	TU5 (BDY/BFZ/NFT/NFV/NFW/
DW12	EW10J4S	F6JB	HHJB	TU9 (CDY/CDZ)	NFY/NFZ)
DW8	EW12	F6JC	TDCI	XU10	
ET3JE	EW12J4	G8DB	TU1 (HDY/HDZ/HFY/HFZ)	XU10JP4	





## 53770

6.15 - 3 36

### ATTREZZO DI REGOLAZIONE CINGHIA DENTATA PER FORD/SEAT/VOLKSWAGEN/MAZDA/VOLVO

#### MODELLO

FORD: FIESTA, FUSION, COURIER, ESCORT, FOCUS, FOCUS C MAX, PUMA, MONDEO, SIERRA, COUGAR, GALAXY, C-MAX, ORION, TOURNEO CONNECT, TRANSIT CONNECT  
 MAZDA :I21  
 SEAT: ALHAMBRA  
 VOLVO: S40, V50  
 VW: SHARAN

#### UTENSILI OEM

U2003	21-123	21-238	23-058	303-367	303-679A	310-085
0132-AB	21-151	21-251	23-059	303-376	303-689	323-029
0178-D	21-162B	21-260	303-0985	303-393	303-732	49JE 02 020
0194-B	21-163	21-262	303-1054	303-393-01	303-734	49JE 02 021
0194-C	21-168	21-263	303-1059	303-620	303-735	
2064	21-210	23-019	303-1061	303-651	303-748	
21-104	21-229	23-020	303-1151	303-652	310-055	
21-105	21-234	23-047	303-193	303-675	310-084	

#### CODICE MOTORE

ABFA	DHF	FFBA	FYJB	HHJA	KKDB	P9PB	RTJ	TYBA	4DA
AFN	DHG	FFWA	FYJC	HHJC	KLBA	QJBA	RTK	TYDA	4EA
AHU	DVTED4 (8HV)	FHA	F3FA	HHJD	KLWA	QJBB	RVA	TYWA	4EB
ANU	DVTED4 (9HZ)	FHE	F4FA	HHJE	KNBA	QJBD	RWPA	TZJA	4EC
ASDA	DV4TD	FIFA	F6JA	HHJF	LPBA	QXBA	RWPC	TZJB	4ED
ASDB	DV4TD (8HW)	FMBA	F6JB	HJBA/B	LQDB	QXBB	R2PA	UFBA	4FA
AUY	DV4TD (8HX)	FMBA/B	F6JC	HWDA	L1E	QXWA	R3PA	UFDA	4FB
AVG	DV4TD (8HZ)	FUJA	F6JD	HWDATZ	L1G	QXWB	SHDA	UFDB	4FC
AZBA	DV4TED4	FUJB	F9DA/B	HXDA	L1K	QYBA	SHDB	UFWA	4FD
AZBC	DV4TED4 (5HY)	FXDA	G6DA	HXJA	L1T	QYWA	SHDC	UGCB	4GA
AZWA	DV6ATED4 (9HX)	FXDA/C	G6DC	HXJB	L1V	Q4BA	SIDA	UKBA	4GB
AZWC	DV6ATED4 (9HY)	FXDB/D	G6DD	H9FA	MZ-CD 1.6	RDA	SNJA	UKDA	4GC
BHPA	D2FA	FXFA	G6DE	H9FB	M7JA	RDB	SNJB	UKDB	4GD
B4164S3	D24	FXJA	G6DF	IQDA/8	M7JB	RFK	SPJA	UKWA	4GE
C9DC	D24T	FXJB	G6DG	IQDB	N7BA	RFN	STJA	Y6	4GF
DHA	D24TIC	FXJC	G8DA	JQDA	N7BB	RHBA	STJB	IZ	4HA
DHB	D3FA	FYDA	G8DB	JTDA	PNBA	RKC	TXBA	4BA	4HB
DHC	D4FA	FYDB	HCPB	JTDB	PNDA	RKD	TXDA	4BB	4HC
DHD	D5BA	FYDH	HHDA	KHBA	P7PA	RQB	TXDB	4BC	4HD
DHE	D6BA	FYJA	HHDB	KKDA	P9PA	RQC	TXWA	4CC	

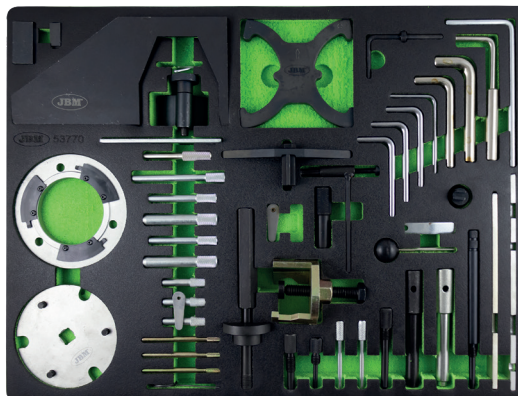

## 53773

6.60 - 3 36

### MODULO DI REGOLAZIONE CINGHIA DENTATA PER FIAT/ALFA/LANCIA/OPEL/SUZUKI/FORD

#### MODELLO

ALFA: ROMERO 145, 146, 147, 155, 156, 159, 166, SPIDER, GTV, TS, GT. CROSSWAGON Q4  
 FIAT: PUNTO, GRANDE PUNTO, BRAVA, BRAVO, MAREA, WEEKEND, STILO, DOBLO, CARGO, IDEA, PANDA, MULTIPLA, PALIO, STILO, 500  
 FORD: KA  
 LANCIA: LYBRA, YPSILON, THESIS, MUSA  
 OPEL: CORSA, AGILA, MERIVA, COMBO, VECTRA, ZARA, ASTRA, ISGNA SIGNUM 1.9 CDTI  
 SUZUKI: IGNIS, SWIFT, WAGON R+

#### UTENSILI OEM

EN-46788	1860905000	1870900400	2190754500
1860161000	1860933000	1871000900	860863000
1860703000	1860965000	1895443000	
1860771000	1860985000	2000004200	
1860845000	1860987000	2000004300	
1860874000	1860992000	2000004400	
1860876000	1870896900	2190754200	
1860898000	1870900300	2190754400	

#### UTENSILI OEM

Z13DT	169A4.000	186A3.000	188A8.000	198A3.000	199B2.000	841C.000	940A3.000
Z13DTH	176B9.000	186A4.000	188A9.000	198A5.000	2233A7.000	841G.000	940A4.000
Z13DTJ	178B3.000	186A6.000	192A1.000	198A6.000	2233A9.000	841H.000	940A5.000
Z19DT	182A6.000	186A8.000	192A3.000	199A2.000	323.02	841P.000	955A3.000
Z19DTH	182B2.000	186A9.000	192A5.000	199A3.000	325.01	843A1.000	955A4.000
Z19DTJ	182B4.000	188A2.000	192A8.000	199A4.000	342.02	937A2.000	
Z19DTL	182B6.000	188A3.000	192A9.000	199A5.000	350A2.000	937A5.000	
Z19DTR	182B9.000	188A4.000	192B1.000	199A7.000	350A3.000	939A1.000	
1182A4.000	185A2.000	188A5.000	192B4.000	199A9.000	362.02	939A3.000	
169A1.000	185A6.000	188A7.000	198A2.000	199B1.000	371.01	939A5.000	



53772

 6.40  -  3  36

## ATTREZZO DI REGOLAZIONE CINGHIA DENTATA PER FORD/VAG/MAZDA/VOLVO

## MODELLO

AUDI: 80, A1, A2, A3, S3, A4, A5, A6, TT, Q5

FORD: GALAXY

SEAT: AROSA, IBIZA, CORDOBA, LEON, TOLEDO, ALHAMBRA, ALTEA, INCA (99-04)

SKODA: FABIA, OCTAVIA, SUPERB

VW: LUPO, POLO, FOX, GOLF, BORA, JETTA, GOLF PLUS, PASSAT, BEETLE, TOURAN, SHARAN, CADDY, CADDY MAXI, TRANSPORTER, GOLF VI CARBO, TIGUAN

## UTENSILI OEM

MP1-1312	T10060	T10121	T10414	T40069	23-058	3366
MP1-301	T10060A	T10123	T20038	T40098	23-059	3369
T00115	T10074	T10170	T20044	U20003	2587	3387
T0015	T10092	T10171	T20102	U30009A	303-1054	3411
T10008	T10098	T10252	T30052	U40021	310-084	3418
T10016	T10100	T10264	T30092	VAS6079	310-085	3458
T10020	T10115	T10340	T30094	2064	3242	
T10050	T10120	T10341	T40026	2065A	3359	

## CODICE MOTORE

ACV	AMG	AUF	AYC	BDG	BJM	BMN	BRF	BVF	CAYB
AFB	ANJ	AUS	AYM	BDH	BKC	BMP	BRM	BVG	CAYC
AFH	ANU	AUY	AYY	BDJ	BKD	BMR	BRR	BVH	CBAA
AFK	ANY	AVB	AYZ	BDK	BKE	BMS	BRS	BVK	CBAB
AFN	APA	AVF	AZD	BE	BKF	BMT	BRT	BVP	CBAC
AGX	APE	AVQ	AZQ	BEW	BKG	BMW	BRU	BVR	CBBA
AHD	AQQ	AVY	AZV	BFG	BKP	BMV	BSS	BWK	CBBB
AHU	ARC	AWX	BAG	BFV	BLB	BNA	BSU	BWV	CBDA
AHW	ARL	AWY	BAY	BGW	BLF	BNM	BSW	BXE	CBDB
AHY	ASZ	AXB	BBE	BHC	BLN	BNU	BTB	BXF	CBEA
AJM	ATD	AXC	BBF	BHP	BLP	BNV	BTS	CAGA	CBZA
AJT	ATJ	AXG	BBY	BHW	BLS	BPW	BUK	CAGB	CBZB
AJV	ATL	AXL	BBZ	BJB	BLT	BPX	BUY	CAGC	CBZC
AKE	ATN	AXP	BCA	BJJ	BMA	BRB	BUZ	CAHA	CEGA
AKQ	AUA	AXR	BCB	BJK	BMB	BRC	BVA	CAXA	CKUB
AMF	AUB	AXU	BCZ	BJL	BMM	BRE	BVE	CAYA	RKD
									IZ



53774

 6.95  -  3  36

## ATTREZZO DI REGOLAZIONE CINGHIA DENTATA PER OPEL/CHEVROLET/SAAB/FIAT/LANCIA/SUZUKI/FORD

## MODELLO

ALFA: 145, 146, 147, 156, 159, 166, GT, CROSSWAGON Q4

CHEVROLET &amp; DAEWOO: EPICA, CAPTIVA, NUBITA, LACETTI, EVANDA

FIAT: PUNTO, GRANDE PUNTO, BRAVO, BRAVAM MAREA, WEEKEND, STILO, DOBLÒ, CARGO, MULTIPLA IDEA, PANDA

FORD: KA

LANCIA: YPSILON, MUSA, LYBRA, THESIS

OPEL: CORSA B/C, COMBO, TIGRA, AGILA, TIGRA B, MERIVA, ASTRA F/G/H, ASTRAMAN, SPEEDSTER VX220, ZAFIRA A/B, VECTRA B/C, SIGNUM, OMEGA B, SINTRA, FRONTERA A/B, ASTRAMAN, KADETT, ASCONA, OMEGA, MONTEREY, ANTARA, CROMA, SPEEDSTER, VX220

SAAB: 9-3, 9-5 (98-04)

SUZUKI: IGNIS, SWIFT, WAGON R+

## UTENSILI OEM

EN-46781	KM-J-43651	KM-927	KM-954	1870896900	303-1468
EN-46785	KM-6130	KM-929	KM-955	1870900300	303-376
EN-46788	KM-6148	KM-932	1860703000	1870900400	303-376B
EN-46789	KM-6349	KM-933	1860905000	1871000200	
EN-48245	KM-852	KM-951	1860905010	1871000900	
EN-48246	KM-853	KM-952	1860985000	21-162B	

## CODICE MOTORE

182B4.000	199A2.000	17D	198A3.000	4EE1/T	C18XEL	X17DT	Y17DTI	Z13DTH	Z19DTL
182B9.000	199A3.000	17DR/X	198A6.000	4FC1/T	C20SEL	X17DTL	Y17DTL	Z13DTJ	Z20DM
186A6.000	199A9.000	185A2.000	199A5.000	4FD1	C20XE	X18XE	Y20DTH	Z14XE	Z20DMH
186A8.000	199B1.000	185A6.000	223A7.000	4JX1/4	D223L	X18XE1	Y20DTL	Z14XEP	Z20LEH
188A2.000	199B2.000	186A9.000	223A9.000	7DTL	JG2T	X20DTH	Y22DTH	Z16SE	Z20LEL
188A3.000	323.02	192A3.000	342.02	841G.000	RA420	X20DTL	Y22DTR	Z16XE	Z20LER
188A7.000	371.01	192A5.000	350A2.000	841H.000	X12XE	X20XEV	Y22SE	Z16YNG	Z20LET
188A8.000	937A2.000	192A8.000	350A3.000	841P.000	X14XE	X22DTH	Y22XE	Z18XE	Z20S1
188A9.000	939A2.000	192B1.000	362.02	939A1.000	X16SEJ	X22SE	Z10XE	Z18XEL	Z22SE
188B2.000	940A3.000	192B4.000	4EC1	939A3.000	X16SZR	X22XE	Z10XEP	Z19DT	Z22XE
192A1.000	169A1.000	194A1.000	4EC1/T	955A3.000	X16XE	Y16XE	Z12XE	Z19DTH	Z22YH
192A9.000	16DA	198A2.000	4EE1	955A4.000	X16XEL	Y17DT	Z13DT	Z19DTJ	

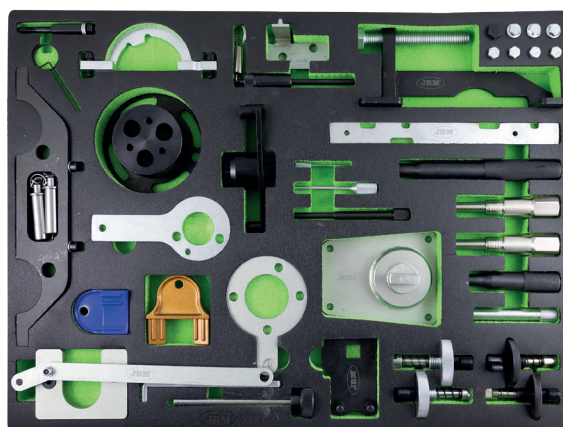

## CARRELLO A 7 CASSETTI

SPECIALE CON MODULI DI UTENSILI SPECIALI PER KIT DI MESSA IN FASE

REF.	CASSETTI	COLORE	ATTREZZATO	PEZZI	MATERIALE					€
53951	7		Con utensili	250	Acciaio	94.70	-	1	4	
53952	7		Con utensili	250	Acciaio	94.70	-	1	4	
54501	7		Con utensili	250	Acciaio	94.70	-	1	4	
54502	7		Con utensili	250	Acciaio	94.70	-	1	4	

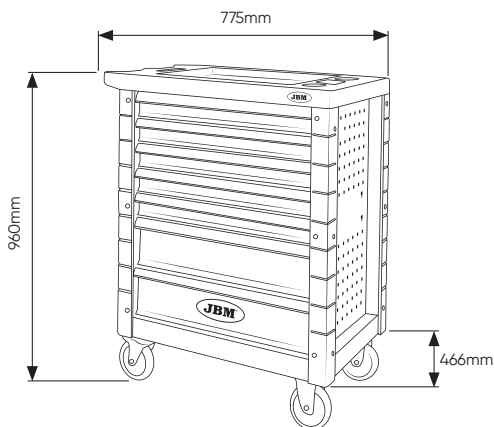

**SPECIFICHE TECNICHE**

Misure piccolo cassetto	74mm	533mm	400mm
Capacità del piccolo cassetto		30Kg	
Misure grande cassetto	151,5mm	533mm	400mm
Capacità del grande cassetto		30Kg	

**IL CARRELLO CONTIENE**

53775

15.50 - 1 6

SET DI 6 MODULI KIT DI MESSA IN FASE

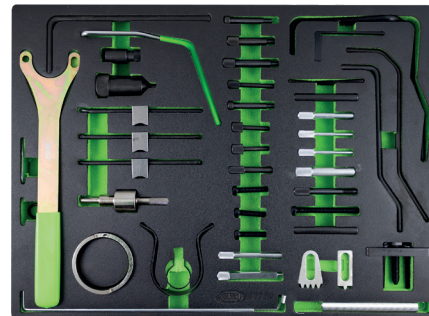

FIAT ALFA ROMEO BMW  
MINI PSA FORD JAGUAR  
LAND ROVER JEEP  
CHRYSLER MERCEDES  
BENTON  
NISSA  
VAG

